

Design and Implementation of RF and Microwave Filters Using Transmission Lines

Rethabile Khutlang

A thesis submitted to the Department of Electrical Engineering,
University of Cape Town, in fulfilment of the requirements
for the degree of Bachelor of Science in Engineering.

Cape Town, October 2006

Declaration

I declare that this thesis report is my own, unaided work. It is being submitted for the degree of Bachelor of Science in Engineering at the University of Cape Town. It has not been submitted before for any degree or examination in any other university.

Signature of Author

Cape Town

23 October 2006

Abstract

RF and Microwave filters can be implemented with transmission lines. Filters are significant RF and Microwave components. Transmission line filters can be easy to implement, depending on the type of transmission line used. The aim of this project is to develop a set of transmission line filters for students to do practical work with.

There are different transmission lines due to different RF and Microwave applications. The characteristic impedance and how easy it is to incise precise lengths are two important characteristics of transmission lines; thus they are used to investigate which transmission line to use to implement filters.

The first part of this project looks into which transmission line to use to erect a filter. Then the different filter design theories are reviewed. The filter design theory that allows for implementation with transmission lines is used to design the filters.

Open-wire parallel lines are used to implement transmission line filters. They are the transmission lines with which it is easiest to change the characteristic impedance. The resulting filters are periodic in frequency. The open-wire lines can be used well into the 1 m wavelength region. For characteristic impedance below 100 Ohms, the performance of open-wire lines is limited.

Acknowledgements

I would like to thank my supervisor, Professor Michael Inggs, for his guidance and tolerance throughout the extent of the project. I have benefitted immensely from his wealth of knowledge.

I would also like to thank Andile Mngadi and Jonathan Ward for their availability whenever help was needed.

Contents

Declaration	i
Abstract	ii
Acknowledgements	iii
1 Introduction	1
1.1 Terms of Reference	1
1.2 Review of the Terms of Reference	2
1.2.1 Introduction	2
1.2.2 Functional Characteristics	2
1.2.3 Interface Characteristics	2
1.2.4 Safety Characteristics	2
1.2.5 Implementation Issues	3
1.2.6 Timescale	3
1.2.7 Test Requirements	3
1.3 Plan of Development	3
2 Literature Review	6
2.1 Filter Design Methods	7
2.1.1 Filter Design by the Image Method	7
2.1.2 Filter Design by the Network Synthesis Method	10
2.2 Transmission Lines.	12
2.2.1 Coaxial Cable	12
2.2.2 Open-Wire Lines	13
2.2.3 Microstrip	13
2.3 Transmission Line Stub Filters	14
2.3.1 Richard's Transformation	14
2.3.2 Kuroda Identities	15

2.3.3	Non-Redundant Filter Synthesis	15
2.4	Transmission Line Resonator Filters	15
2.4.1	Impedance and Admittance Inverters	16
2.4.2	Quarter-Wave Coupled Filters	16
2.5	Implementation of Filters	17
2.5.1	Stepped-Impedance Filters	17
2.5.2	Waveguide Filters	17
2.5.3	Fixed Impedance Coaxial Cable Filters	17
2.5.4	Open-wire Parallel Lines Filters	21
2.6	Summary	21
3	Filter Designs	22
3.1	Design of a Low-Pass Filter	23
3.2	Design of a High-Pass Filter	25
3.3	Design of a Band-Pass Filter	27
3.4	Design of a Band-Stop Filter	29
3.5	Conversion of Lumped-Elements to Distributed Elements	31
3.5.1	Low-pass Filter	31
3.5.2	High-Pass Filter	32
3.5.3	Band-Pass Filter	33
3.5.4	Band-Stop Filter	33
3.6	Summary	33
4	Implementation of Filters	35
4.1	Implementation of the Low-Pass Filter	35
4.2	Implementation of the High-Pass Filter	37
4.3	Implementation of the Band-Pass and Band-Stop Filters	37
4.4	Translation of the Filter Impedance	37
4.4.1	The Balun	37
4.4.2	Coaxial Cable	38
4.4.3	Connectors	38
4.5	Summary	39
5	Testing	40
5.1	E5071B Network Vector Analyser Calibration	40
5.2	Low-Pass Filter Test	42
5.3	The High-Pass Filter Test	44
5.4	Discussion of Results	46

6	Conclusions and Recommendations	49
6.1	Conclusions	49
6.2	Recommendations	49

List of Figures

2.1	L-section Network. [1, page 56]	7
2.2	Constant -k half section. [1, page 62]	8
2.3	m- derived half section. [1, page 64]	9
2.4	A two port network.	18
2.5	The Smith Chart.	20
3.1	Power loss ratio of the low-pass prototype.	23
3.2	Lumped elements low-pass filter prototype.	24
3.3	Simulated low-pass filter circuit.	24
3.4	Simulation Results for the low-pass filter.	25
3.5	Lumped elements high-pass filter prototype.	25
3.6	Simulated high-pass filter circuit.	26
3.7	Simulation results for a high-pass filter.	27
3.8	Lumped elements band-pass filter prototype.	28
3.9	Simulated circuit for a band-pass filter.	28
3.10	Simulation results for a band-pass filter.	29
3.11	Lumped elements band-stop filter prototype.	30
3.12	Simulated circuit for a band-stop filter.	30
3.13	Simulation results for a band-stop filter.	31
3.14	Inductors and capacitors converted to series and shunt stubs.	32
3.15	Series stubs converted to shunt stubs.	32
4.1	Open-wire line low-pass filter.	36
4.2	Transformers connected back-to-back and coaxial cable.	38
4.3	Transformers connected to the low-pass filter.	39
5.1	The test set up.	40
5.2	The plot of S_{11} .	41
5.3	The plot of S_{21} .	42
5.4	Magnitude response of the low-pass filter.	43

5.5	Phase response of the low-pass filter.	43
5.6	Group delay of the low-pass filter.	44
5.7	Magnitude response for a high-pass filter.	45
5.8	Phase response of the high-pass filter.	45
5.9	Group delay of a high-pass filter.	46
1	a	53
2	b	53
3	c	54
4	d	54

List of Tables

3.1	Characteristic impedance of the resonators.	33
4.1	Centre-to-centre spacing of sections of low-pass filter.	36

Chapter 1

Introduction

This report describes the design and implementation of RF and Microwave transmission line filters. The reason for the initiation of the project is to increase practical work for the fourth year electrical engineering course: "RF and Microwave Systems" (EEE 4086F) at the University of Cape Town. The course has adequate theory but still has to increase the portion of its practical work.

Filters are amongst the most common RF and Microwave components. Their function is intuitively easy, for instance a low-pass filter should pass low frequency signals. It is easy to figure out that the characteristic of merit is frequency. Because of their importance, there is an immense amount of theory dedicated to the design of filters. Students learn about some of the filter design theory in the fourth year course, consequently it is a good idea to consolidate the theory with some practical work.

The theory required for the design and implementation of the RF and Microwave filters has been gathered from relevant books, the Internet and discussions with members of the radar research group at the University of Cape Town. The main constraint on the project has been time.

1.1 Terms of Reference

The terms of reference of this thesis are as follows:

- Investigate which transmission lines can be used to implement RF and Microwave filters.
- Determine which filter types can be built using the transmission lines.
- Design and implement the filters using the transmission lines and connectors. The design can be with the aid of the Smith Chart.
- In the designs, include the effects of the stray capacitance of the connectors.
- Test the designed filters.

- Prepare an appendix that forms a practical, as the work carried out in this project is to form practical work for students.

1.2 Review of the Terms of Reference

1.2.1 Introduction

The Requirements Review clarifies what work the thesis entails. The project involves the design and implementation, thus the aim is to finally submit a set of working filters. The first part of the project is researching which transmission lines to use in the implementation of RF and Microwave filters. The second part is the implementation of filters.

1.2.2 Functional Characteristics

The most common RF and Microwave filters are the low-pass, high-pass, band-pass and band-stop filters. Quarter-wave resonators, shunt stubs, stepped impedance, comb-line and inter-digital are some of the forms of implementing transmission line filters. Filters pass the signals in their pass-band and attenuate signals in their stop-band. The attenuation of the signals in the stop-band depends on the characteristic design of the filter. Microstrip, stripline, suspended substrate, open-wire line, coaxial cable or rods coupled through an aperture can be used in implementing filters because they are all transmission lines.

1.2.3 Interface Characteristics

The RF and Microwave filters designed in this thesis are to form a demonstration for students taking the course EEE4086F. The students are to experiment with the filters. The dominant RF and Microwave experimentation equipment is the network vector analyzer. Therefore the filters should be interfaced to connect to the network vector analyzer. RF and Microwave connectors come in different sizes and types. Transmission lines can require a non-conducting platform to be mounted on; therefore transmission line filters to be designed should have proper supports to be mounted onto.

1.2.4 Safety Characteristics

There are no safety concerns with this project. In operation, the filters should connect to the network vector analyser which transmits power levels below any ionising energy. The only concern could be heat, but this is offset by the low power levels transmitted by the network vector analyzer. Open-wire lines easily radiate energy, however when connected to the network vector analyzer the energy levels cannot compromise safety as they are low. Based on the power levels of the network vector analyzer, the designs of the filters do not include safety.

1.2.5 Implementation Issues

There is no specialised machinery to be used in the implementation of the filters. The design is based on the methods established in the literature review. The transmission line to be used can be processed using cutters and the vernier caliper to incise the required dimensions. Due to the absence of precise specialised equipment to determine the form of the transmission lines, accuracy is an issue and it should be taken into account. Transmission line materials needs to be purchased, an account of the compromise between cost and electrical conductivity of the materials is to be given as electrical conductivity of the material affects the performance of the filter.

1.2.6 Timescale

The thesis project is conducted during the second semester of the university's academic year. The commence date is the beginning of semester and the hand-in date of the report is 23rd October 2006. There are no fixed dates to be adhered to during the implementation of this project. Nonetheless there is a crude order of execution of this project. Firstly the literature is to be reviewed, then the design, implementation and testing is to follow. The plan is to reserve the last month for the thesis write-up.

1.2.7 Test Requirements

The designed filters are tested to establish if they perform as required. The tests are part of the process to ascertain if the project met all the set requirements. To compare designed filters against what the design hypothesize, experiments can be set up.

1.3 Plan of Development

Chapter 2 presents the literature reviewed in this thesis project. There are many ways to design RF and Microwave filters. Chapter two is the review of the literature on filter design. It compares and contrasts the different filter design methods. The filters are implemented using transmission lines; therefore the chapter discusses different transmission lines. The motivation for a particular choice of a transmission line is detailed in this chapter.

Conceptually, the simplest filter design method is the image method [1, page 84]. The image method is compared and contrasted with the network synthesis method. Network synthesis method is based on the transfer function of the circuit. An example of the transfer function is the transmission coefficient. From the transfer function of the circuit the input impedance of a circuit can be found [2, page 154]. The input impedance can be expanded to give the element values of the circuit.

There are different types of transmission lines. The different types of transmission lines arise because of their different applications. The parallel wire transmission lines are probably among the earliest types as they arose in the dawn of telecommunications. Also they are the easiest to make. Coaxial cable is mainly reserved for applications of set constant

impedance. On the other hand, microstrip transmission line is suitable for printed circuit boards.

Chapter two discusses the use of different transmission lines in the implementation of transmission line filters. Preliminary filter designs are done in order to compare implementation issues of different transmission lines. The transmission line that is perceived to be the easiest to use to implement filters is chosen. The basis of the choice is given in chapter two.

In conclusion, chapter 2 reviews the RF and Microwave filter design literature. It establishes which design theory to use and provides reasons behind the choice of theory. Furthermore, the transmission line to implement filters is decided from the initial designs. The next chapter details the design of filters using the chosen filter design theory; the filters are implemented with the transmission line established from the initial designs.

Chapter 3 presents the Filter Designs. Filters are designed using the theory that allows for the implementation using transmission lines. This chapter is the development of the theory that leads to the designs. Low-pass, high-pass, band-pass and band-stop filters are designed. The design involves conversion of lumped elements into distributed elements if the initial design is in lumped-elements. Simulation is to be used to verify the amplitude and phase responses of the designs.

For most filter design theories the initial designs are in lumped-elements. Therefore the initial designs are given in lumped-elements. The terms of reference states that the designs should be implemented with transmission lines. Lumped elements cannot go up to very high frequencies. Again capacitors and inductors, reactive elements, have terrible tolerances; capacitors can have 20% tolerance [3]. Filters designed with capacitors have the worst case designs that are way off the ideal values. Consequently lumped element designs are converted into distributed components designs.

The order of the filter determines its behaviour. Usually the higher the order, the better the filter performs. For transmission line filters the order is related to the ease of implementation. Accordingly, there is a compromise between the order of the filter and the difficulty of implementation. The order of a filter is selected so that the physical dimensions of the transmission line are realisable.

The two common characteristics of transmission lines are characteristic impedance and physical dimensions. The two common characteristics of filters are frequency and rate of attenuation in the stop-band. The frequency of the filter is more likely to affect the length of the transmission line than its characteristic impedance. Therefore a compromise is to be made between the frequency of operation and the physical dimensions of the filter.

Chapter three presents the designs of low-pass, high pass, band-pass and band-stop filters. Cut-off frequencies and the impedance of operation are chosen with implementation issues in mind. The designed filters are simulated. The next chapter discusses filter implementation.

Chapter 4 presents the Implementation of Filters. The distinguishing characteristic of

transmission lines is their characteristic impedance. Filter design methods involve impedance, as the input impedance or the operating impedance of the filter. Thus implementation of transmission line filters is centred on chosen transmission line's characteristic impedance. The length of the transmission line is also a significant characteristic, so the ease of determining specific lengths of transmission line is an advantage.

Filter designs are done with ease of implementation in mind. Besides that, some of the filter designs might still be difficult to implement. The length or characteristic impedance of the transmission line determines the performance of the filter. Some of the required lengths or characteristic impedances may not be met with the transmission line chosen based on initial designs. Therefore an account of filters not implemented should be given.

Chapter four is the implementation of filters. An account is given for filters that could not be implemented. The aim is to use one kind of transmission line for the implementation of a filter. The filters have the right connectors to be interfaced to other RF and Microwave components or the test equipment. The subsequent chapter is on filter tests.

Chapter 5 documents the testing of the filters. Most design work in the RF and Microwave field follows well established theory. In spite of that, the designs are tested to verify that they perform as stipulated by theory. The same logic applies to this project. The filters designed and implemented using transmission lines are tested to prove the design theory. Chapter five reports on the tests conducted to the implemented filters.

The important filter parameters are the insertion loss in both the pass-band and the stop-band; the shape of the cut-off point and the insertion loss increase rate. Some of the filter design methods are based on periodicity of structures, therefore periodicity of filters can be observed. The shape of amplitude and phase responses can be compared to that of the simulation results.

To test the filters, experiments are set. The objective of the experiments is to capture the behaviour of the implemented filters. The main equipment used is the network vector analyser. The same filter types should have the same procedure of testing. The methods of collecting the results are similar for all filters.

The implementation of RF and Microwave filters does not involve any specialised machinery in this project. The implementation is crude as it aims for transmission lines' stubs that can be attained using only cutters. Some transmission line filter designs results in closely spaced stubs or finely changing lengths or impedances; they are normally implemented with specific machinery. Such designs cannot be implemented for this project. Therefore the results of the tested filters are less accurate; hence they are extensively discussed.

Chapter five ends with the discussion of the results. The discussion of results explains the differences between the test results obtained and the simulation of the designs. The variations are explained so that conclusions can be drawn on the project.

Chapter 6 is the conclusions and recommendations. The final chapter concludes and provides recommendations for the future work on the subject.

Chapter 2

Literature Review

There are many ways to design RF and Microwave filters. Chapter two is the review of the literature on filter design. It compares and contrasts the different filter design methods. The filters are implemented using transmission lines; therefore the chapter discusses different transmission lines. The motivation for a particular choice of a transmission line is detailed in this chapter.

Filters are two-port networks used to control the frequency response in an RF or Microwave system. They allow transmission of signal frequencies within their pass-band, and attenuate signals outside their pass-band. Common RF and Microwave filter types are listed below:

- Transmission line stubs filters. These filters are implemented using transmission lines in place of lumped elements.
- Coupled line filters. Filters can be designed using transmission lines as resonators coupled together using quarter-wave matching transformers [4].
- Inter-digital filters. They are formed from short-circuited transmission lines that take the structure of interlaced fingers [4].
- Comb-Line filters. Quarter-wave transmission line resonators are used in the design of comb-line filters. Quarter-wave transmission lines are capacitively coupled [4].
- Waveguide discontinuity filters. The low loss and high power handling characteristics of waveguides lend themselves to the use of waveguides in specialized filters [4].
- Elliptic function filters. They are implemented using N coupled transmission lines between parallel plates. The network is a $2N$ port network that is reduced to an N port network by leaving all the ground ports open-circuited [5, page 73].

2.1 Filter Design Methods

2.1.1 Filter Design by the Image Method

The image viewpoint for the analysis of circuits is a wave viewpoint much the same as the wave viewpoint commonly used for analysis of transmission lines [1, page 49]. Such circuits include filters. Therefore filters can be designed by the image method. Uniform transmission line characteristic impedance can again be its image impedance, if γt is the line's propagation constant per unit length then $\gamma t l$ is the image propagation function for a length l [1, page 49].

The Image Parameters

The relation between the image parameters and the general circuit parameters, for example open-circuit and short-circuit impedances, is that transmission properties of general circuits can be defined in terms of their image parameters [1, page 52]. For example, the image properties of the L-section network, Figure 2.1

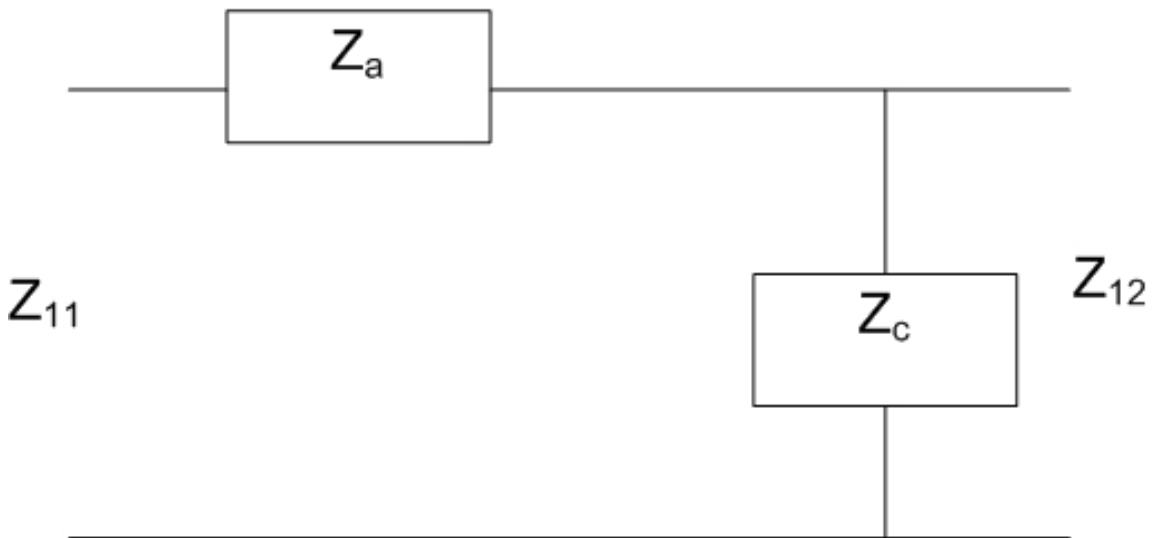

Figure 2.1: L-section Network. [1, page 56]

are

$$Z_{11} = \sqrt{Z_a(Z_a + Z_c)}$$

$$Z_{12} = \frac{Z_a Z_c}{\sqrt{Z_a(Z_a + Z_c)}}$$

$$\gamma = \coth^{-1} \sqrt{1 + Z_c/Z_a}$$

Z_{11} , Z_{12} and γ are the image parameters. Z_a and Z_c are the transmission properties of the L-section network [1, page 54].

Constant -k and m- Derived Filter Sections

Constant -k and m- derived sections are designed from the image point of view. Below are the image properties of the dissipation-free sections. They are normalised so that their image impedance is $R' = 1$ at $\omega' = 0$ and their cut-off frequency occurs at $\omega'_1 = 1$ radians / sec.

Normalised constant -k filter half section

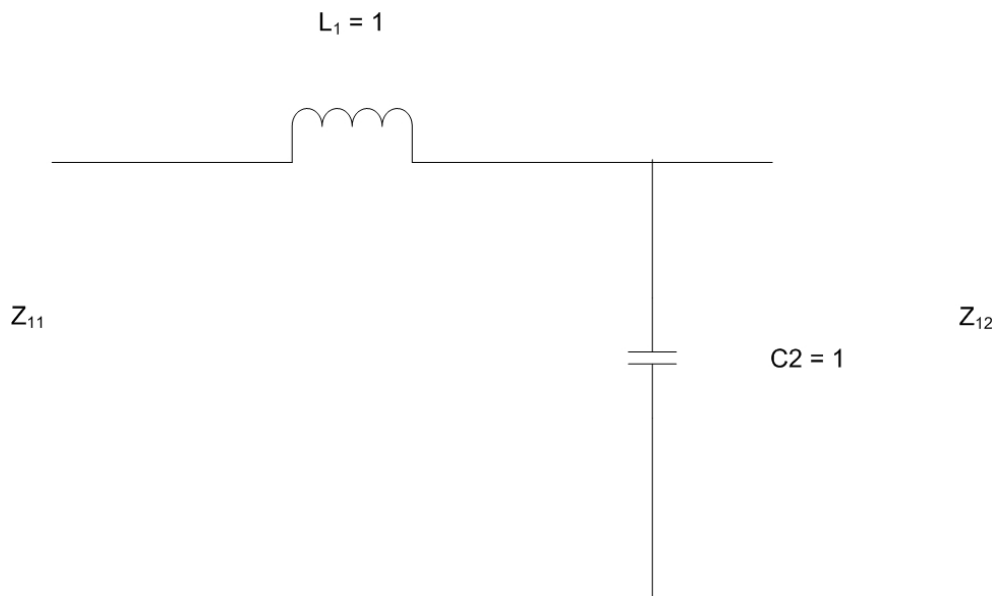

Figure 2.2: Constant -k half section. [1, page 62]

Its image impedances are

$$Z_{11} = \sqrt{1 - (\omega')^2}$$

and

$$Z_{12} = \frac{1}{Z_{11}}$$

Its propagation function is

$$\gamma = \alpha + j\beta = 0 + j \sin^{-1}(\omega')$$

for the $0 \leq \omega' \leq 1$ pass-band, and

$$\gamma = \alpha + j\beta = \cosh^{-1}(\omega') + j\pi/2$$

for the $1 \leq \omega \leq \infty$ stop-band, where α is in nepers and β is in radians [1, page 61].

Normalised series, m- derived half section

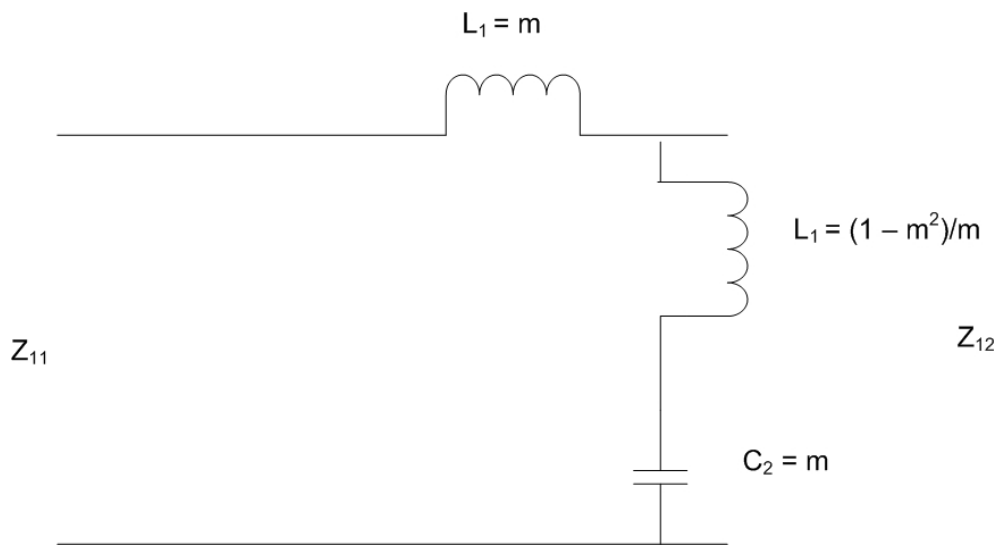

Figure 2.3: m- derived half section. [1, page 64]

Its image impedances are

$$Z_{11} = \sqrt{1 - (\omega')^2}$$

and

$$Z_{12} = \frac{1 - (\frac{\omega'}{\omega'_\infty})^2}{\sqrt{1 - (\omega')^2}}$$

where

$$\omega'_\infty = \frac{1}{\sqrt{1 - m^2}}$$

the propagation constant is

$$\gamma = \alpha + j\beta = 0 + j(1/2) \cos^{-1}\left[1 - \frac{2m^2}{(\frac{1}{\omega'})^2 - (1-m^2)}\right]$$

in the $0 \leq \omega \leq 1$ pass-band, and

$$\gamma = (1/2) \cosh^{-1}\left[\frac{2m^2}{(\frac{1}{\omega'})^2 - (1-m^2)} - 1\right] + j\pi/2$$

in the $1 = \omega' \leq \omega' \leq \infty$ stop-band, and

$$\gamma = (1/2) \cosh^{-1}\left[1 - \frac{2m^2}{(\frac{1}{\omega'})^2 - (1-m^2)}\right]$$

In the $\omega' \leq \omega' \leq \infty$ stop-band [1, page 63].

Constant -k and m- derived half sections can be connected together to form a filter. With sections chosen so that image impedances match at the junctions, the image attenuation and the image phase for the entire structure are simply the sum of the image attenuations and the phase values of the individual sections [1, page 68].

The resistive terminations to an image filter do not match its image impedance. Therefore matching end sections are designed to improve the response of the filter. The m- derived half sections are used as the matching end sections [1, page 72]. They improve the pass-band response of the filter and can further sharpen the cut-off characteristic of the filter.

The m- derived half sections reduce the reflections at the filter ends. On the other hand, they give no assurance as to how large the peak reflection loss values may be in the pass-band [1, page 84]. Thus, though the image method is conceptually simple, it requires a great deal of trial and error if accurately defined band edges and low pass-band reflection loss are required.

2.1.2 Filter Design by the Network Synthesis Method

The network synthesis method is based on the transfer function of the circuit. An example of the transfer function is the transmission coefficient. From the transfer function the input impedance of a circuit can be found[2, page 154]. The input impedance can be expanded to give the element values of the circuit.

Darlington [6] is among the first to come up with network synthesis methods. However, there are recent methods that are more concise. Insertion loss method is one of the common network synthesis methods. It is used in the design of filters by the network synthesis method below.

Insertion loss results from the insertion of a device in a transmission line. It is expressed as the reciprocal of the ratio of the signal power delivered to that part of the line following the device to the signal power delivered to that same part before inserting the device [7]. Insertion loss method applies to the design of low-pass, high-pass, band-pass and band-stop filters. There are trade-offs between insertion loss, sharp cut-off and good phase response. Thus there are maximally flat, equal-ripple and linear phase filter responses. Insertion loss (IL) in dB is defined by

$$IL = 10PLR$$

Where PLR is the power loss ratio $PLR = \frac{1}{(1-|\Gamma(\omega)|^2)}$ [2, page 152].

Maximally Flat Response Filter

Maximally flat filter response has the flattest amplitude response in the pass band. For the low-pass filter, it is defined by

$$PLR = 1 + k^2\left(\frac{\omega}{\omega_c}\right)^{2N}$$

where N is the order of the filter and ω_c is the cut-off frequency. For $\omega \gg \omega_c$, insertion loss increases at the rate of $20N$ dB per decade increase in frequency [2, page 153].

Equal-Ripple Response Filter

Equal-Ripple Filter Response is defined by

$$PLR = 1 + k^2T_N^2\left(\frac{\omega}{\omega_c}\right)$$

where $T_N^2(x)$ is a Chebyshev polynomial of order N . The pass-band response has ripples of amplitude $1 + k^2$, while the stop-band insertion loss increases at the rate of $20N$ dB per decade in frequency [2, page 153].

Linear Phase Response Filter

Linear phase response filter specifies the phase of the filter. A linear phase characteristic has the following response

$$\phi(\omega) = A\omega[1 + p(\frac{\omega}{\omega_c})^{2N}]$$

where $\phi(\omega)$ is the phase of the voltage transfer function and p is a constant. Group delay is the derivative of the phase characteristic [2, page 153].

Maximally flat, equal-ripple and the linear phase response filters have low-pass filter prototypes. The low-pass filter prototypes can be transformed into high-pass, band-pass, or stop-pass filters. There are tables to design filters from the low-pass filter prototypes. The tables are derived from the equations for the equivalent filter responses. The tables list the reactive elements of the filter and the generator input impedance as well as the load impedance. The element values are given for filter orders from one to ten. The impedances and the frequency of operation are normalised. Finally filter prototypes need to be converted to usable impedance level and cut-off frequency by scaling.

There are two ladder circuits for low-pass filter prototypes. The first begins with a shunt element, and the second begins with a series element. For the ladder circuit beginning with a shunt element, the generator has series internal resistance; whilst the generator has shunt internal conductance for a ladder circuit beginning with a series element. The two ladder circuits are used interchangeably, with considerations to the final filter symmetry. Specifying the insertion loss at some frequency within the stop-band determines the size or order of the filter [2, page 156].

The image method for filter design does not give assurance as to how large the peak reflection loss values are in the pass-band. The network synthesis method for filter design applies tables of low-pass lumped elements filter prototypes. The use of such prototypes to determine the parameters of the RF or Microwave filter eliminates the guess work inherent in image method filter design [1, page 84]. Thus insertion loss method is chosen for filter design. The discussion of different transmission lines follows.

2.2 Transmission Lines.

There are different types of transmission lines. The different types of transmission lines arise because of their different applications. The parallel wire transmission lines are probably among the earliest types as they arose in the dawn of telecommunications. Also they are the easiest to make. Coaxial cable is mainly reserved for applications of set constant impedance. On the other hand, microstrip transmission line is suitable for printed circuit boards.

2.2.1 Coaxial Cable

Coaxial cable is mainly used in applications that require fixed impedance. It is made from two conductors, where one is central and the other completely surrounds it. The

two conductors are separated by a continuous solid dielectric or sometimes by periodic dielectric spacers [8]. The central line carries the signal, while the outermost line acts as ground [9]. The characteristic impedance of coaxial cable is

$$Z_o = \frac{138}{\sqrt{\epsilon_r}} \log\left(\frac{D}{d}\right)$$

where ϵ_r is the dielectric constant, D is the inner diameter of the outer conductor, d is the diameter of the inner conductor. Twisted pair copper wire and optical fibre are alternatives to coaxial cable depending on the carrier technology used [9]. Coaxial cable is a solution to many problems, from wide bandwidth to low loss and high isolation [8].

2.2.2 Open-Wire Lines

Parallel lines are balanced transmission lines. They have various types, for example the flat TV 300 Ohm ribbon [10]. Open-wire lines are made out of copper wire and non-conducting spacers. Wooden dowels, plastic rods, and strips of vinyl siding are among the materials that can be used to make spacers [11]. However polycarbonate rods with assured RF characteristics are the most reliable materials. The open-wire lines do have the disadvantage that they must be kept away from other conductors and earthed objects. Also as frequency increases the open-wire line spacing becomes a significant fraction of the wavelength and the line will radiate [11].

The characteristic impedance of the open-wire line depends on its physical properties[11]. It is

$$Z_o = 120 \cosh^{-1}\left(\frac{s}{d}\right)$$

where d is the diameter of the wire and s is the centre-to-centre spacing of the wires. The equation involving the common logarithms is generally used [11].

$$Z_o = 276 \log\left(\frac{2s}{d}\right)$$

2.2.3 Microstrip

Microstrip transmission line consists of a track of copper or other conductor on an insulating structure. There is a sheet of the similar conductor on the other side of the insulator.

The track of copper acts as a passage of the signal while the sheet on the other side provides a return path; therefore microstrip is a variant of two-wire transmission line [12]. Microstrip is predominantly used in printed circuit boards.

If thickness of the copper track is t and the width W of the copper track is less than the height h of the insulating material, the effective dielectric constant ε_{eff} is [13]

$$\varepsilon_{eff} = \frac{\varepsilon_r + 1}{2} + \frac{\varepsilon_r - 1}{2} \left[\frac{1}{\sqrt{1 + \frac{12h}{W}}} + 0.04 \left(1 - \frac{W}{h}\right)^2 \right]$$

where ε_r is the relative dielectric constant. If the width of the track is greater than the height of the insulator, ε_{eff} constant becomes

$$\varepsilon_{eff} = \frac{\varepsilon_r + 1}{2} + \frac{\varepsilon_r - 1}{2} \left[\frac{1}{\sqrt{1 + \frac{12h}{W}}} \right]$$

The characteristic impedance is

$$Z_o = \frac{120\pi}{2\sqrt{2\pi\sqrt{\varepsilon_r + 1}}} \ln \left\{ 1 + \frac{4h}{W'} \left[\frac{14 + 8/\varepsilon_{eff}}{11} \frac{4h}{W'} + \sqrt{\left(\frac{14 + 8/\varepsilon_{eff}}{11} \right)^2 + \left(\frac{4h}{W'} \right)^2 + \frac{1 + 1/\varepsilon_{eff}}{2} \pi^2} \right] \right\}$$

where: $W' = W + \Delta W'$

$$\Delta W' = \Delta W \left[\frac{1 + 1/\varepsilon_{eff}}{2} \right]$$

$$\Delta W = \frac{t}{\pi} \ln \left[\frac{4e}{(t/h) + (\frac{1}{W/t + 1})} \right]$$

2.3 Transmission Line Stub Filters

The filters discussed in section 2.1.2 are lumped element filters. Lumped elements are available for a limited microwave frequency range. In addition, at microwaves frequencies the electrical distance between filter components is not negligible. For this reasons, distributed components such as open- or short-circuited transmission lines are used as reactive elements [2, page 168].

2.3.1 Richard's Transformation

Richards transformations are used to convert lumped elements to transmission line stubs, where the transformation [2, page 168]

$$\Omega = \tan \beta l = \tan \left(\frac{\omega l}{v_p} \right)$$

maps the ω plane to the Ω plane. If frequency variable ω is replaced with Ω , a short-circuited stub of length βl and characteristic impedance L , replaces the inductor; while an open-circuited stub of length βl and characteristic impedance $1/C$ replaces the capacitor. The cut-off occurs at unity frequency for a low-pass filter prototype; to get the same cut-off frequency after applying the Richard's Transforms,

$$\Omega = 1 = \tan \beta l$$

should hold. Then the input impedance of the inductor equals that of the corresponding short-circuit; the input impedance of the capacitor equals that of the corresponding open-circuit.

2.3.2 Kuroda Identities

There are four Kuroda identities [see appendix A]. They use redundant transmission line sections to achieve a more practical microwave filter implementation by performing any of the following operations:

- Physically separate transmission line stubs.
- Transform series transmission line stubs into shunt stubs and the other way around.
- Change impractical characteristic impedance into more realisable ones.

The additional transmission lines are called unit elements [2, page 169].

2.3.3 Non-Redundant Filter Synthesis

The unit elements alleviate the implementation limitations set by the practical considerations. They enable the construction of transformer end sections and admittance inverters for band-pass filters [5, page 193]. The unit elements can also be used to improve filter response in addition to easing filter implementation [5, page 193]. Such implementation is called non-redundant filter synthesis. But redundant filter synthesis relies on tables of lumped element prototypes; these tables do not contain unit elements. Therefore non-redundant filter synthesis does not have a lumped element counterpart [2, page 169].

2.4 Transmission Line Resonator Filters

Band-pass filters are very important in RF and Microwaves systems. Their pass-band is very selective in a wide frequency range. In wireless systems they are used to reject

out of band and image signals. They attenuate unwanted mixer products, and set the IF bandwidth. Because of their importance, a large number of different types of band-pass filters have been developed [2, page 178].

2.4.1 Impedance and Admittance Inverters

Band-pass filter prototypes are derived from low-pass filter prototypes. The transformations result in conversion of an inductor to an LC series resonator for band-pass filters and to an LC parallel resonator for band-stop filters. Resonators are difficult to implement using transmission line sections. While the Kuroda Identities are useful for transforming capacitors or inductors to either series or shunt transmission line stubs, they are not useful for transforming LC resonators [2, page 178]. For this purpose, impedance and admittance inverters are used. These techniques apply to band-pass and band-stop filters that have bandwidth less than 10% [2, page 178].

An impedance inverter converts load impedance to its inverse, while an admittance inverter converts load admittance to its inverse:

$$Z_{\text{in}} = \frac{K^2}{Z_L}$$

$$Y_{\text{in}} = \frac{J^2}{Y_L}$$

K is the impedance inverter constant and J is the admittance inverter constant [2, page 179]. Impedance and admittance inverters transform between series-connected and shunt-connected elements. For example, an admittance inverter converts a parallel LC resonator into a series LC resonator. Quarter-wave transformers can be used to implement inverters. The characteristic impedance of the transformer would equal the inverter constant.

2.4.2 Quarter-Wave Coupled Filters

Quarter-wave short-circuited transmission line stubs behave like parallel resonant circuits, hence they are used as the shunt parallel LC resonators for band pass filters [2, page 179]. Shunt parallel resonators are connected by quarter-wave transmission lines which act as admittance inverters. If open-circuited stubs are used, band-stop filters results.

The designs do not apply to low-pass equal-ripple filter prototypes with even order because the input and output impedances of the filter ought to be equal [2, page 182]. The disadvantage of the design is that the resulting characteristic impedances of the stubs are very low; capacitively coupled quarter-wave resonators can be used to improve the characteristic impedances.

2.5 Implementation of Filters

2.5.1 Stepped-Impedance Filters

One way to implement low-pass filters is to use microstrip or stripline lines of alternating high and low characteristic impedance. Such filters are called stepped impedance filters; they are easy to design and take up less space compared to filters using stubs [2, page 173]. Due to their nature, highest and lowest feasible impedance transmission lines, their performance is lower than that of stub filters. They are used when sharp cut-off is not required.

There are numerous equivalent circuits for a short section of a transmission line. T-equivalent circuit is an example of an equivalent circuit for a short transmission line section. For a transmission line section with electrical length much smaller than $\pi/2$ radians, if it has large characteristic impedance it represents an inductor; if it has small characteristic impedance it represents a capacitor. Therefore series inductor of low-pass prototype filter can be replaced with high impedance transmission line section, and shunt capacitor with low impedance section. The ratio of the impedances should be as high as possible [2, page 175].

2.5.2 Waveguide Filters

Filters designed using insertion loss method can be implemented using waveguides. The waveguide filter is in most respects the dual of the capacitive-gap coupled filter; it operates like a filter with series resonators [1, page 450]. The low-pass filter prototype transformations for waveguide filters are the same as those of the capacitive-gap coupled if both transformations are expressed in terms of guide wavelength [1, page 450]. Waveguide parameters can be determined from the waveguide handbook charts. The implementation assumes the presence of only the TE₁₀ mode. If other modes are present, they disrupt the performance of the filter.

2.5.3 Fixed Impedance Coaxial Cable Filters

Coaxial cable is the first transmission line to be reviewed for the implementation of filters. There are different types of coaxial cable each categorised by its characteristic impedance. Lengths of coaxial cable can be connected together using BNC connectors. A T BNC connector connects two redundant elements and a transmission line stub together. Smith Chart is used to determine the input impedance of the cable length; while the network vector analyser is used to test the filter designs. The designs can be tested by observing the scattering parameters of the filter.

Insertion loss filter design method allows for two degrees of freedom when implementing filters using transmission lines. The degrees of freedom are the length of the transmission line and its characteristic impedance. Coaxial cable has fixed characteristic impedance, but allows for the second degree of freedom - the length of the transmission line.

BNC Connectors

There are various types of connectors used to connect RF and microwave components. The BNC connectors connect transmission lines sections together. They are ideally suited for cable terminations for miniature or sub-miniature coaxial cable [14]. A 75 Ohm BNC connector can provide constant 75 Ohm performance with low VSWR for the frequency range DC-4 GHz [14].

S-Parameters

The set of two-port parameters used for high frequency signals are known as the scattering parameters, S-parameters. The input and output parameters are known as the incident and reflected parameters respectively. S-parameters are normalised to the characteristic impedance of the system. Figure 2.4 shows the S-parameters of a two port network.

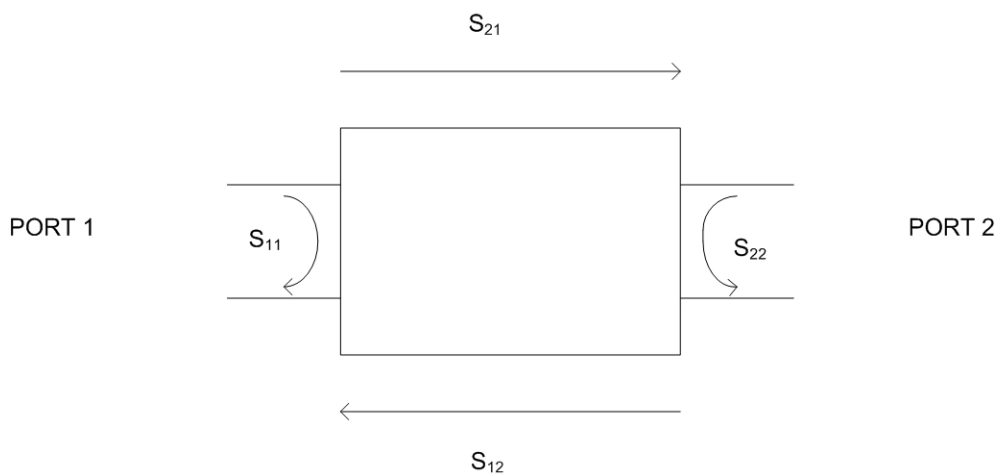

Figure 2.4: A two port network.

- S_{11} is the reflection coefficient seen at port 1.
- S_{22} is the reflection coefficient seen at port 2.
- S_{21} is the transmission coefficient from port 1 to port 2.
- S_{12} is the transmission coefficient from port 2 to port 1.

Smith Chart

The RF and microwave transmission line equations show that there are important relationships between:

- Voltage reflection coefficient.
- Load, characteristic and input impedances.
- Voltage standing wave ratio (VSWR).

The equations linking these relationships are complex and cumbersome. The Smith Chart offers a graphical method to determine these inter-relationships [15]. It is composed of curves of constant resistance and reactance. The resistance extends from zero to infinity along the horizontal axis; the reactance extends from zero to infinity and is symmetric about the horizontal axis. The Smith Chart can be used for impedances or admittances calculations. It is mainly used for stub matching and impedance transformation.

Network Vector Analyser

Network vector analyser (NVA) is used to analyse the electrical performance of RF and microwave components. Vector network analysis is a method of accurately characterizing such components by measuring their effect on the amplitude and phase of swept-frequency and swept-power test signals [16]. The NVA is useful in measuring the transmission and reflection characteristics, S-parameters, of any two-port device over a range of frequencies.

Analysis of Filter Implementation by Coaxial Cable

Insertion loss filter design method utilises transmission line sections of fixed length and varying characteristic impedance. Transmission line sections of fixed length are commensurate lines. The input impedance of any of the commensurate lines depends on its characteristic impedance.

Coaxial cable can be used to implement a filter designed by the insertion loss method. Coaxial cable has fixed characteristic impedance but the length is flexible. In Figure 2.5, Smith Chart is used to analyse the usage of coaxial cable to implement an insertion loss method filter.

the coaxial cable plot that intersects the red star for the coaxial cable to replace the $\lambda/8$ transmission line. But such intersection does not occur. Therefore there is no length of coaxial cable for which the input impedance is similar to that of the $\lambda/8$ transmission line. Coaxial cable cannot replace the $\lambda/8$ transmission line. Hence coaxial cable of fixed characteristic impedance cannot be used to implement transmission line filters designed by the insertion loss method.

2.5.4 Open-wire Parallel Lines Filters

Open-wire parallel lines can be used to implement transmission line filters. Transmission line filters have stubs that are either open-circuited or short-circuited. Open-wire lines can implement such stubs. The stubs are connected together using redundant unit elements, such elements can be realised by the open-wire lines. The open-wire line unit elements and stubs can be welded together.

Redundant filter synthesis yields filters that have transmission line stubs of varying characteristic impedances. Such filters are designed using the insertion loss network synthesis method. The transmission line stubs can be realised with open-wire lines of varying centre-to-centre spacing for different characteristic impedances.

2.6 Summary

Chapter 2 reviews the RF and Microwave filter design literature. The filters are to be implemented with transmission lines. Filter design by the image method is conceptually the easiest filter design theory. There are two fundamental building blocks for image method filters, they are the constant $-k$ and m - derived filter sections. The downfall of filter design by the image method is that the designs do not specify pass-band behaviour of the filter. Filter design by the insertion loss method define both the pass-band and stop-band performance of the filter. Insertion loss method is chosen to design the filters.

Transmission line filters are more versatile than lumped elements filters. Insertion loss filter design method produces lumped element filters. Richard's transforms translate lumped element filters into distributed components filters. Kuroda identities are used to achieve a practical filter implementation. For certain wavelengths, transmission lines can act as resonators; therefore they can be used to implement band-pass or band-stop filters.

There are different transmission lines due to various applications. Coaxial cable is the major transmission line. It is the first to be investigated for filters implementation. However coaxial cable cannot be used to implement filters designed by the insertion loss method. It is feasible to implement insertion loss method filters by open-wire parallel lines.

Chapter 3

Filter Designs

Filters are designed using the theory that allows for the implementation using transmission lines. This chapter is the development of theory that leads to the designs. Low-pass, high-pass, band-pass and band-stop filters are designed. The design involves conversion of lumped-elements into distributed elements if the initial design is in lumped-elements. Simulation is to be used to verify the amplitude and phase responses of the designs.

The filters are designed by the insertion loss method. The design equations from the text *Microwave and RF Design of Wireless Systems* [2] are used for the filter designs. There are tables of element values for low-pass filter prototypes. The source impedance and the cut-off frequency are normalised to one. The elements values are derived from the power loss ratio. Power loss ratio depends on the reflection coefficient. The reflection coefficient in turn depends on impedance; at the input, the reflection coefficient is calculated from the input impedance with respect to the filter load impedance. The tables list the reactive element values and the resistive load of the filter for orders from one to ten.

There are two ladder circuits for low-pass filter prototypes; the ladder circuit for the prototype beginning with a shunt reactive element and the ladder circuit for the prototype beginning with a series reactive element. If the first element is a series reactive element, the generator has internal parallel resistance. Else if the first element is a shunt reactive element, the generator has internal series resistance [2, page 156].

Signals in the pass-band of a filter are either maximally flat or have equal ripples in magnitude. The cut-off point is the point where the signal is at 3 dB of attenuation. In the stop-band, signals are attenuated at a rate that depends on the type of filter. For the same order, equal-ripple filters have the higher rate of attenuation than maximally flat which in turn have higher rate of attenuation than linear phase filters. Design of third order equal-ripple low-pass filter follows.

3.1 Design of a Low-Pass Filter

The equal-ripple low-pass filter of order N is specified by the power loss ratio (PLR)

$$PLR = 1 + k^2 T_N^2\left(\frac{\omega}{\omega_c}\right)$$

where $T_N^2(x)$ is a Chebyshev polynomial. High-pass, band-pass and band-stop filters are designed from the low-pass filter prototype. Figure 3.1 is the Matlab plot of the PLR for a 3 dB equal-ripple low-pass filter prototype of order 3.

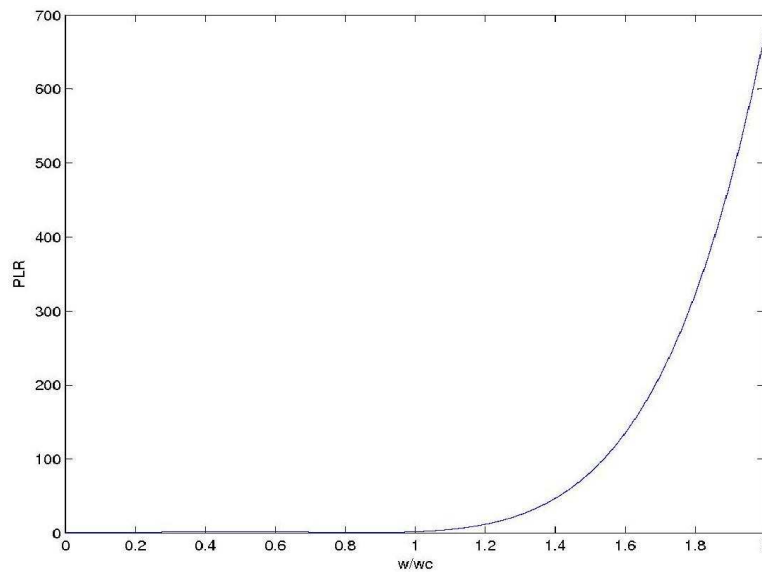

Figure 3.1: Power loss ratio of the low-pass prototype.

The element values of the normalised prototype are as follows:

- $g1 = 3.3487$
- $g2 = 0.7117$
- $g3 = 3.3487$

and the output impedance is 1. The internal conductance of the signal source is normalised to one. A ladder circuit that begins with a series element is chosen. Therefore $g1$ is an inductor so is $g3$, while $g2$ is a capacitor, Figure 3.2.

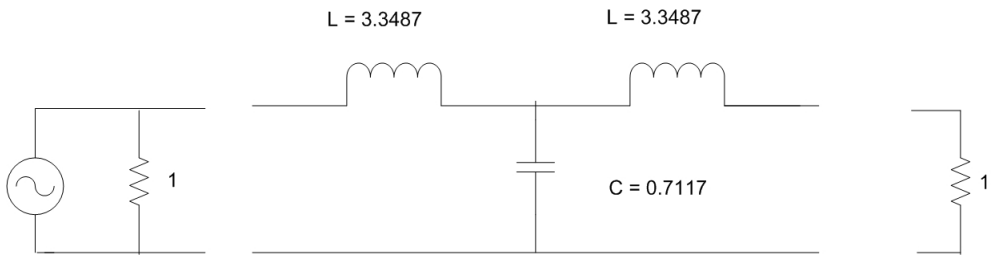

Figure 3.2: Lumped elements low-pass filter prototype.

The cut-off frequency is set at 750 MHz and the impedance at 100 Ohms. Figure 3.3 is the circuit simulated in 5Spice Analysis software. The simulation results are shown in Figure 3.4.

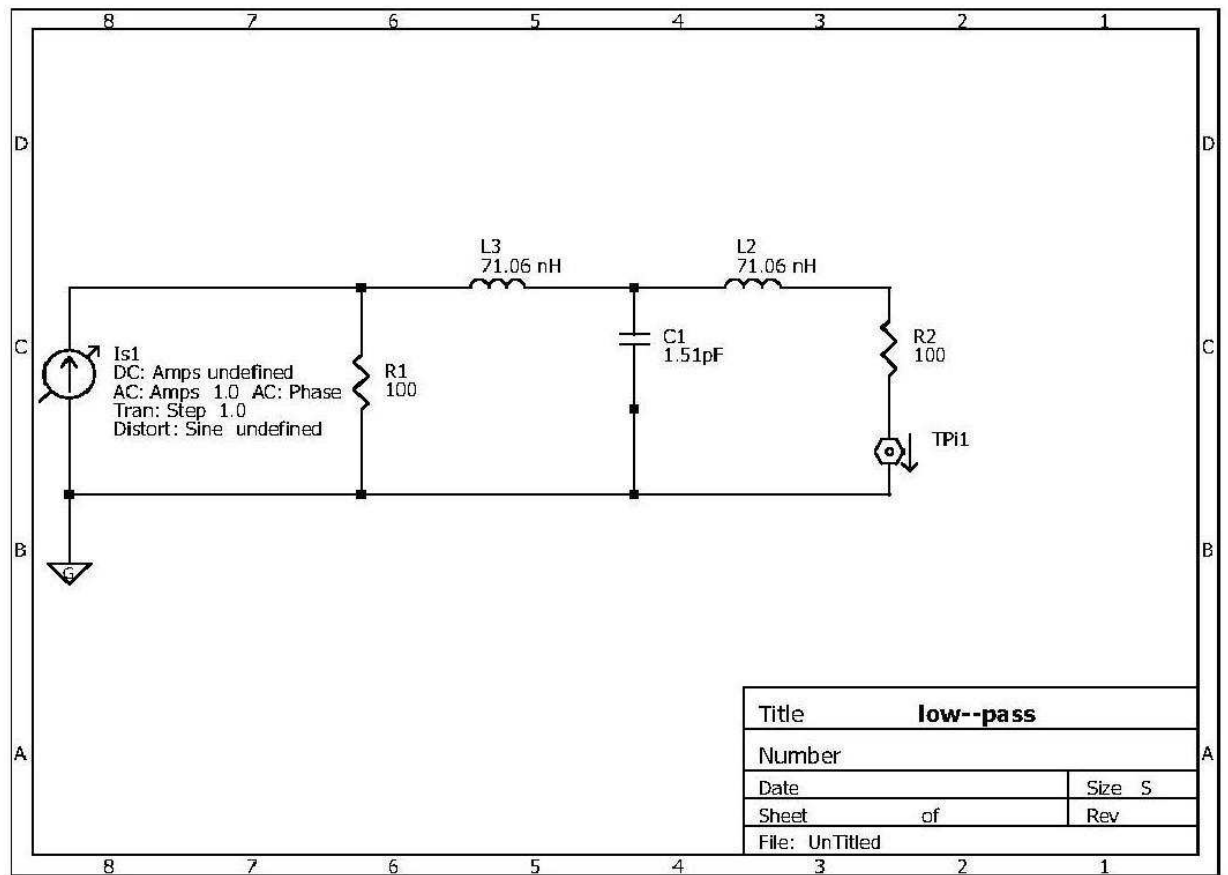

Figure 3.3: Simulated low-pass filter circuit.

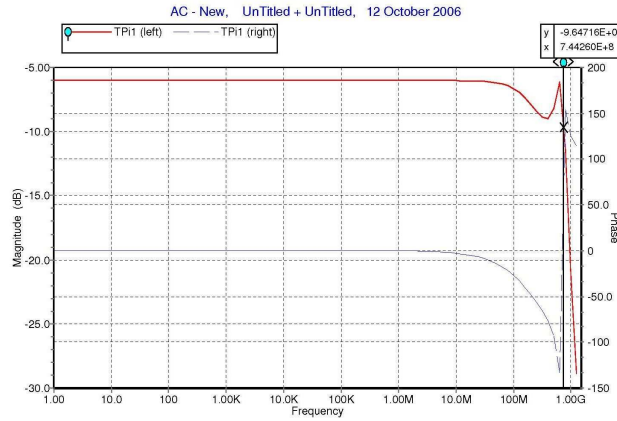

Figure 3.4: Simulation Results for the low-pass filter.

3.2 Design of a High-Pass Filter

The equal-ripple high-pass filter of order N is specified by power loss ratio

$$PLR = 1 + k^2 T_N^2 \left(\frac{-\omega c}{\omega} \right)$$

The element values of the normalised prototype are as follows:

- $g_1 = 3.3487$
- $g_2 = 0.7117$
- $g_3 = 3.3487$

and the output impedance is 1. The signal source has internal conductance normalised to one. A ladder circuit that begins with a series element is chosen. Therefore g_1 is a capacitor so is g_3 , while g_2 is an inductor, Figure 3.5.

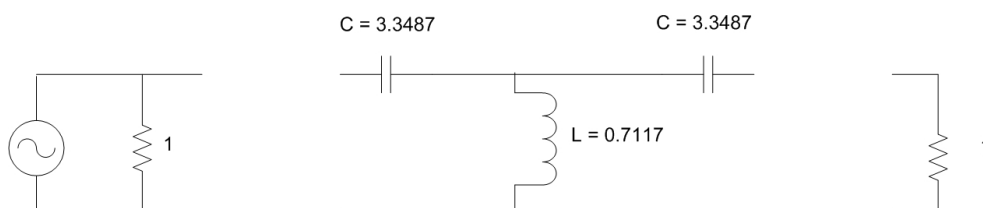

Figure 3.5: Lumped elements high-pass filter prototype.

The cut-off frequency is set at 750 MHz and the impedance at 100 Ohms. Figure 3.6 is the lumped elements circuit simulated in 5Spice Analysis software. The simulation results are shown in Figure 3.7.

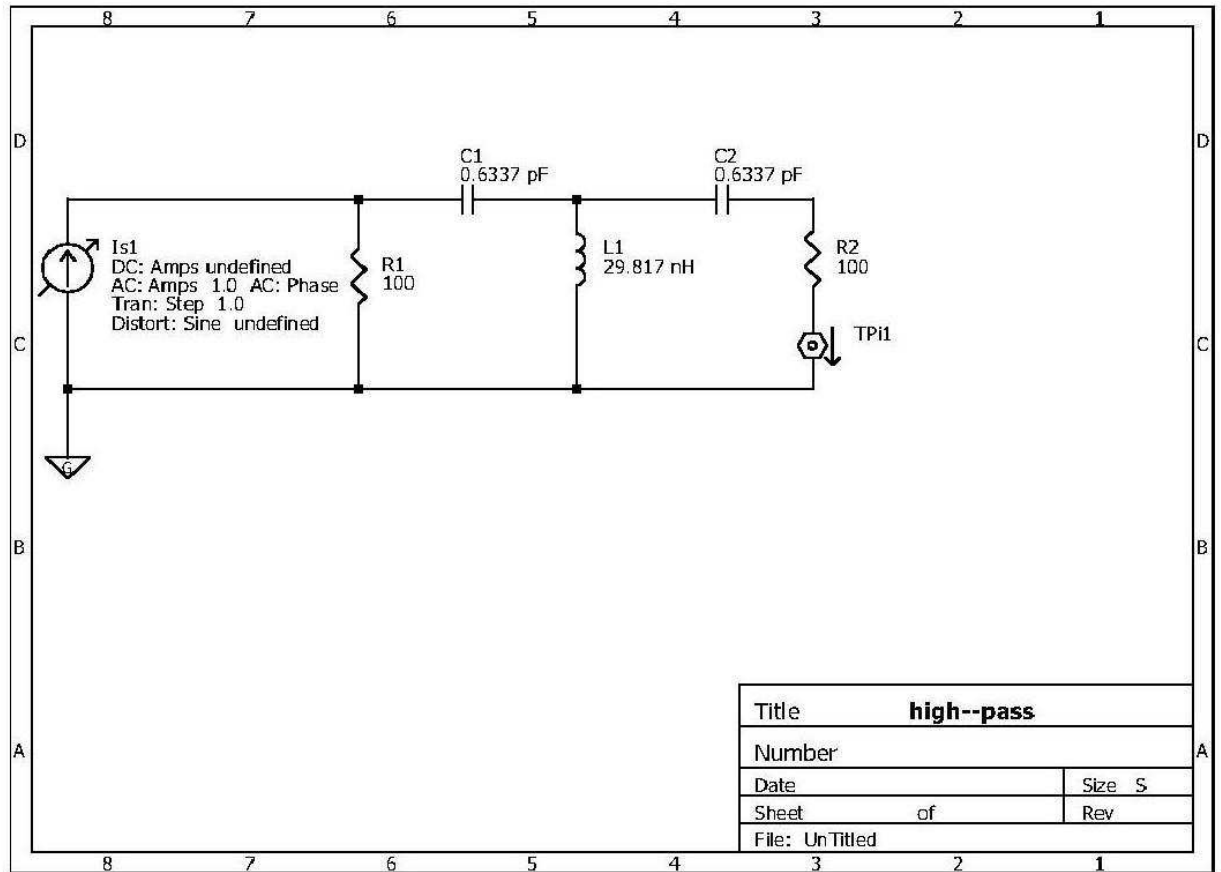

Figure 3.6: Simulated high-pass filter circuit.

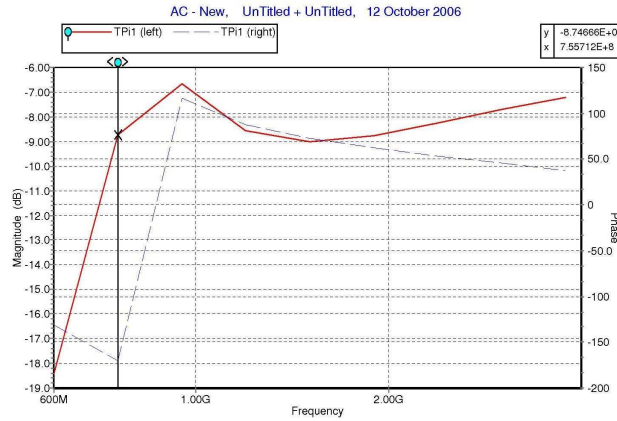

Figure 3.7: Simulation results for a high-pass filter.

3.3 Design of a Band-Pass Filter

The following frequency substitution transforms the power loss ratio of the low-pass filter to that of the band-pass filter

$$\omega \leftarrow \frac{\omega_0}{\omega_2 - \omega_1} \left(\frac{\omega}{\omega_0} - \frac{\omega_0}{\omega} \right)$$

for the same order and type. ω_0 is the centre frequency, while ω_1 and ω_2 denote the edges of the pass-band.

The third order low-pass filter prototype yields the following values for the normalised band-pass filter elements:

- $g_1 = 3.3487$
- $g_2 = 0.7117$
- $g_3 = 3.3487$

and the output impedance is 1. The internal conductance of the signal source is normalised to one. A ladder circuit that begins with a series element is chosen. g_1 and g_3 are inductors and g_2 is a capacitor. For a band-pass filter, low-pass prototype series inductor converts into a series LC circuit, whereas a shunt capacitor converts into a shunt LC circuit, Figure 3.8 illustrates.

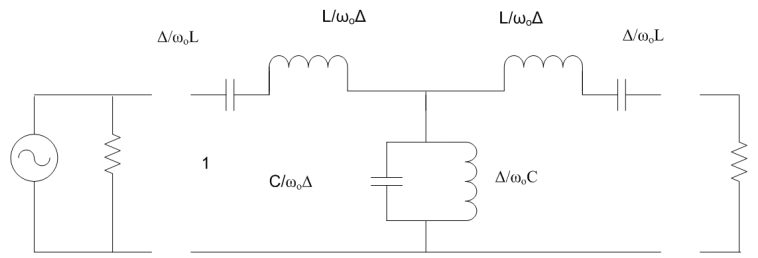

Figure 3.8: Lumped elements band-pass filter prototype.

The centre frequency is set at 750 MHz and the impedance at 100 Ohms. The fractional bandwidth is 10%. Figure 3.9 is the circuit simulated in 5Spice Analysis software. The simulation results are shown in Figure 3.10.

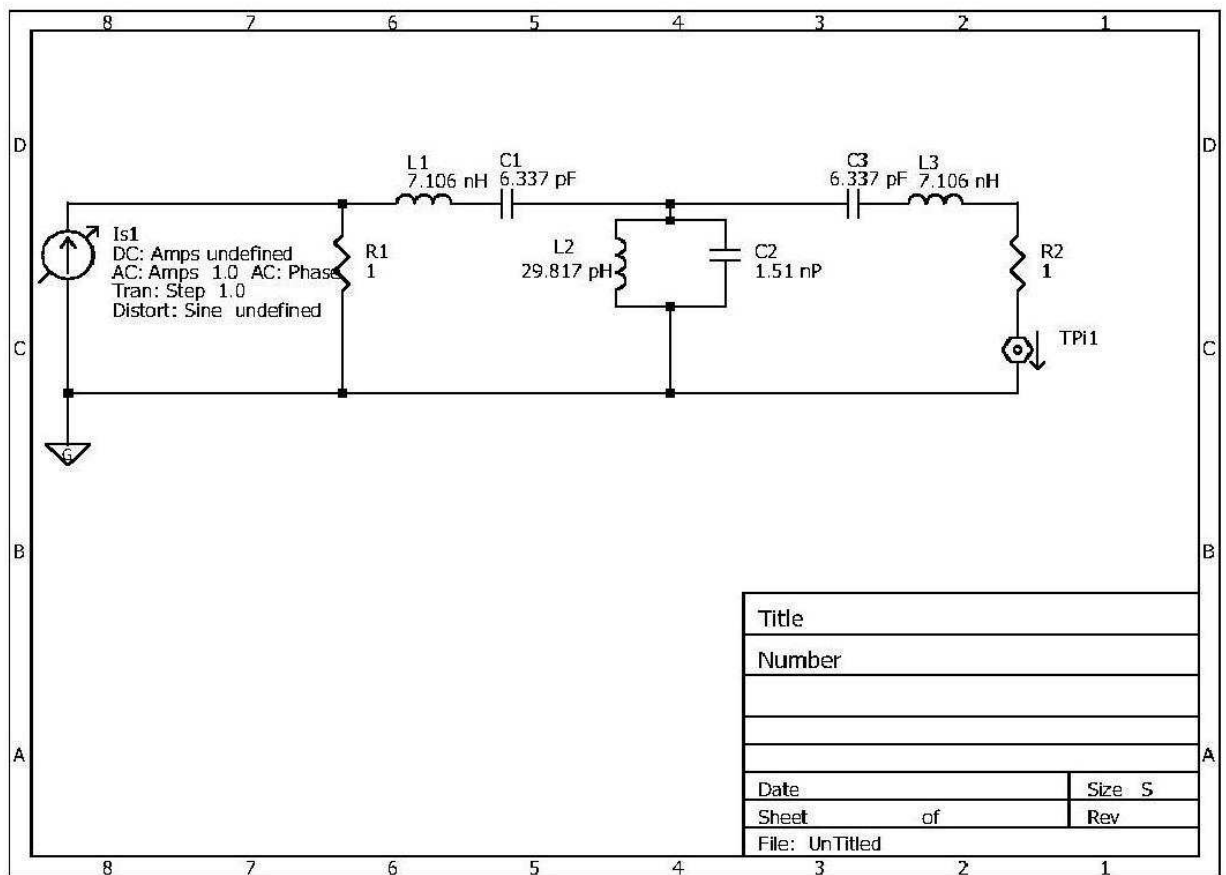

Figure 3.9: Simulated circuit for a band-pass filter.

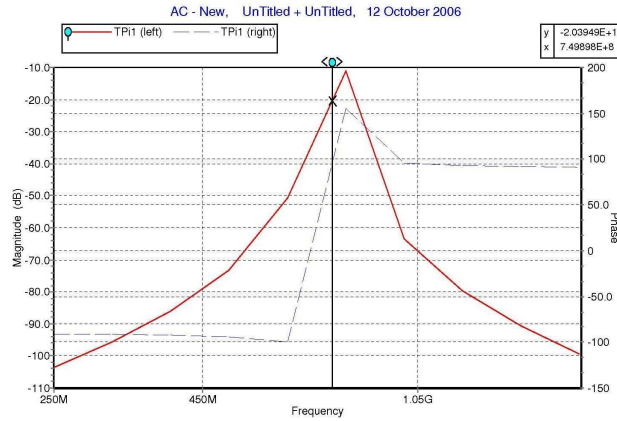

Figure 3.10: Simulation results for a band-pass filter.

3.4 Design of a Band-Stop Filter

Band-stop filter is the opposite of the band-pass filter. The power loss ratio of a band-stop filter is determined from that of the low-pass filter with the following frequency substitution

$$\omega \leftarrow \frac{\omega_2 - \omega_1}{\omega_0} \left(\frac{\omega}{\omega_0} - \frac{\omega_0}{\omega} \right)^{-1}$$

The third order low-pass filter prototype yields the following values for the normalised band-stop filter elements:

- $g_1 = 3.3487$
- $g_2 = 0.7117$
- $g_3 = 3.3487$

and the output impedance is 1. The internal conductance of the signal source is normalised to one. A ladder circuit that begins with a series element is chosen. g_1 and g_3 are inductors and g_2 is a capacitor. For a band-stop filter, low-pass prototype series inductor converts into a parallel LC circuit, whereas shunt capacitor converts into a series LC circuit. Figure 3.11 is a lumped element band-stop filter.

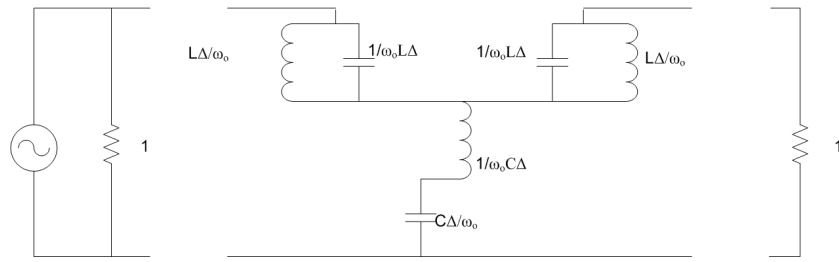

Figure 3.11: Lumped elements band-stop filter prototype.

The centre frequency is set at 750 MHz and the impedance at 100 Ohm. The fractional bandwidth is 10%. Figure 3.12 is the circuit simulated in 5Spice Analysis software. The simulation results are shown in Figure 3.13.

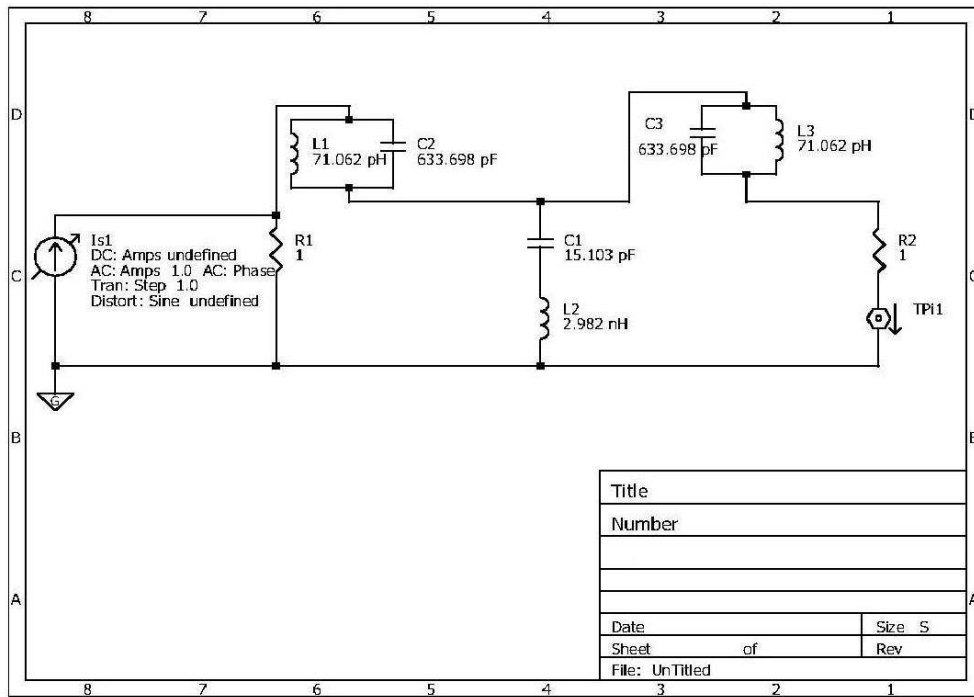

Figure 3.12: Simulated circuit for a band-stop filter.

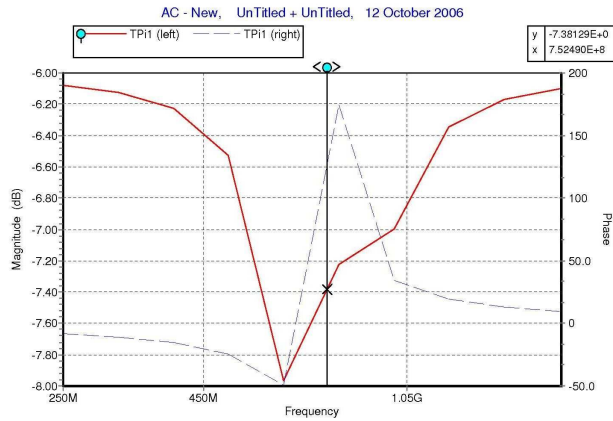

Figure 3.13: Simulation results for a band-stop filter.

3.5 Conversion of Lumped-Elements to Distributed Elements

3.5.1 Low-pass Filter

The next step is to use Richard's transformations to convert series inductors to series short-circuited stubs, and shunt capacitors to shunt open-circuited stubs. The characteristic impedance of a shunt stub is $1/C$, whilst that of the series stubs is L .

A Kuroda identity is used to convert a series stub into a shunt stub. First redundant elements are added to each end of the filter, redundant means they do not affect the filter performance since they are matched to the normalised source impedance. Then the Kuroda identity is used. It states that if the unit element and the serial short-circuited transmission line are swapped, the impedance of the transmission line is multiplied by n^2 and the characteristic impedance of the resulting shunt open-circuited stub is divided by n^2 . The process is illustrated by Figures 3.14 and 3.15.

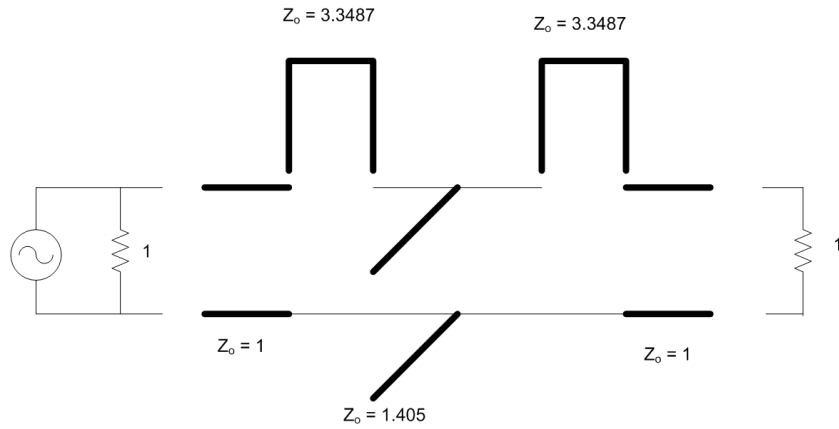

Figure 3.14: Inductors and capacitors converted to series and shunt stubs.

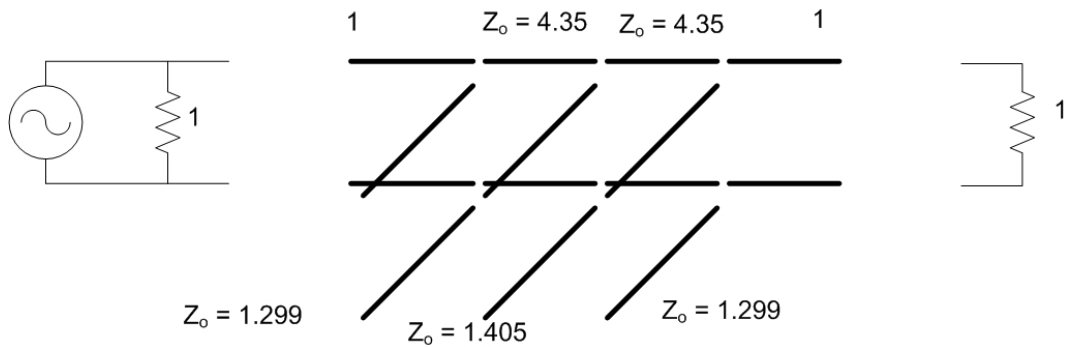

Figure 3.15: Series stubs converted to shunt stubs.

where

$$n^2 = 1 + \frac{Z_2}{Z_1} = 1 + \frac{1}{3.3487}$$

The length of the stubs and redundant elements is $\lambda/8$ at cut-off frequency.

3.5.2 High-Pass Filter

Transmission lines are periodic structures [4]. Periodic structures generally exhibit pass-band and stop-band characteristics in various bands of wave number determined by the nature of the structure [4]. Accordingly transmission line filters are periodic in frequency; their frequency response repeats every $4\omega c$. For the same type and order, low-pass filter response is the reverse of high-pass filter response. The distributed components high-pass

filter is established by changing the termination to low-pass filter stubs from open-circuit to short-circuit.

3.5.3 Band-Pass Filter

Quarter-wave short-circuited transmission line stubs are used to implement shunt parallel LC resonators for band-pass filters [2, page 179]. The resonators are connected together by quarter-wave transmission lines. The transmission lines act as admittance inverters. They convert alternating parallel resonators to series resonators. The characteristic impedance of the connecting transmission line equals the inverter constant section 2.4.

The characteristic impedance of the n th resonator is

$$Z_{on} = \frac{\pi Z_o \Delta}{4g_n}$$

Table 3.1 shows the characteristic impedance of the resonators.

Table 3.1: Characteristic impedance of the resonators.

n	g_n	$Z_{on}(\text{ohms})$
1	3.3487	2.345
2	0.7117	11.036
3	3.3487	2.345

3.5.4 Band-Stop Filter

If the short-circuited transmission line stubs for a band-pass filter are substituted with the open-circuited stubs, a band-stop filter results. The characteristic impedances of the resonators for a third order equal-ripple band-stop filter are equal those of the band-pass filter Table 3.1.

The centre frequency of the transmission line filters is set at 750 MHz. Transmission line electrical length equals βl [15]. The electrical length of a transmission line is inversely proportional to its wavelength. Wavelength is inversely proportional to the frequency of operation; therefore for high centre frequency an error in electrical length becomes a significant fraction of the electrical length.

3.6 Summary

Insertion loss method yields lumped elements filters. Each filter type has a power loss ratio from which normalised reactive element values are derived. Filters are designed us-

ing the low-pass filter prototypes. High-pass, band-pass and band-stop 3 dB equal-ripple filters are designed from their equivalent low-pass filter prototypes. Richard's transforms are used to convert lumped elements filter into distributed elements filters. The impedance of operation is selected as 100 Ohms.

The order of the designed filters is chosen to be three. The choice is made to ease implementation. The implementation of transmission line filters is based on characteristic impedance changes. The higher the order of the filter, the difficult the required changes in characteristic impedance become. However, performance of a filter improves with an order increase.

The reactive values of an insertion loss method filter are derived from the power loss ratio of the filter type designed. To verify the designs, the filters are simulated using the 5Spice Analysis simulation software. The filters designed are of the order three, therefore the simulation shows the minimum performance characteristics of the filter types designed.

Chapter 4

Implementation of Filters

The distinguishing characteristic of transmission lines is the characteristic impedance. Filter design methods also involve impedance, as the input impedance or the operating impedance of the filter. Thus implementation of transmission line filters is centred on chosen transmission line's characteristic impedance. The length of the transmission line is also a significant characteristic, so the ease of determining specific lengths of transmission line is an advantage.

Open-wire parallel lines are used to implement the designed filters. Insertion loss filter design method allows for two degrees of freedom when implementing filters using transmission lines. The degrees of freedom are the length of the transmission line and its characteristic impedance. Open-wire lines have the two degrees of freedom.

The higher the characteristic impedance of the open-wire line, the less change in impedance is brought by an error in the spacing of the parallel lines. Hence the characteristic impedance of the filters should be set as high as possible. Nevertheless, the characteristic impedance of the open-wire lines has a limit. It is limited by the spacing of the conductors that constitute the open-wire lines. For a diameter less than 5 mm, if the centre-to-centre spacing of the conductor exits 150 mm, radiation of the conductors becomes very significant [11]. Furthermore at impedances corresponding to 150 mm spacing, a transformer with an impedance ratio of about 1:12 is needed to convert the impedance to 50 Ohms. Such transformers are very rare, especially at frequencies above 500 MHz.

The characteristic impedance of the filters is 100 Ohms; it is chosen so to do away with the problem of stubs that have characteristic impedance as low as 80 Ohms. Such stubs can not be implemented using open-wire lines because centre-to-centre spacing is less than the diameter of the line. For characteristic impedance above 100 Ohms, the centre-to-centre spacing is always greater than the diameter of the wire used.

4.1 Implementation of the Low-Pass Filter

The third order low-pass 3 dB equal-ripple filter is implemented with open-wire parallel lines. Parallel lines are balanced transmission lines. The characteristic impedance of the

open-wire line depends on its physical properties.[11], it is

$$Z_o = 276 \log\left(\frac{2s}{d}\right)$$

where d is the diameter of the wire and s is the centre-to-centre spacing of the wires. The diameter of the wire is 2.4 mm. The wire is an Aluminium wire with an electrical conductivity of 61% relative to copper, which is taken to be 100% [17]. The centre-to-centre spacing s is given by

$$s = \frac{d}{2} 10^{Z_o/276}$$

Table 4.1 gives the centre-to-centre spacing of the different sections of the low-pass filter.

Table 4.1: Centre-to-centre spacing of sections of low-pass filter.

section	impedance (ohms)	centre-to-centre spacing (mm)
unit elements	435	45.2
central stub	140.5	3.858
outer stubs	129.9	3.54

The central stub is welded to the mid-point of the filter length.

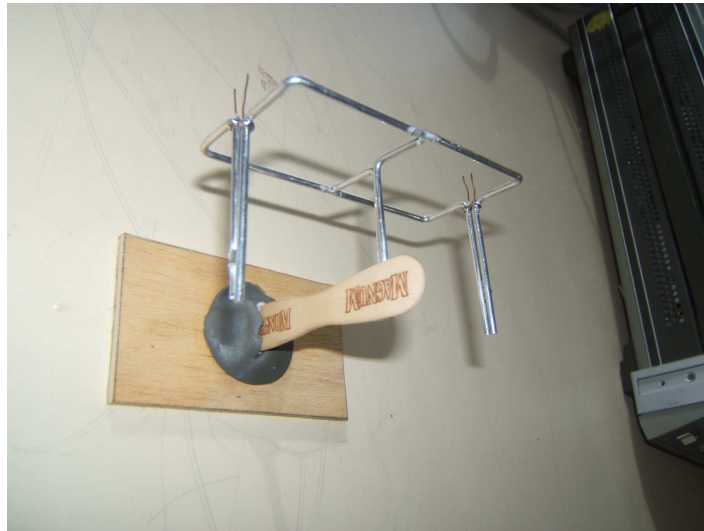

Figure 4.1: Open-wire line low-pass filter.

I used the spacers made out of the wood to keep the separation of the open wires. The filter is mounted on a non conducting board.

4.2 Implementation of the High-Pass Filter

The filters are designed from the insertion loss method. Insertion loss method yields the lumped-element filter. Richard's transforms are used to transfer the lumped-elements to the distributed components. The resulting design has short-circuited stubs in place of inductors and open-circuited stubs in place of capacitors. Kuroda identities are used to change the filter so that it only has shunt stubs. In the case of the low-pass filter all the shunt stubs are open-circuited.

The high-pass filter is the converse of the low-pass filter. With lumped elements, if capacitors are changed for inductors and inductors are changed for capacitor the low-pass filter turns into a high-pass filter with the same cut-off point. With distributed components, if an open-circuited stub is replaced with a short-circuited stub and a short-circuited stub is changed to an open-circuited stub then the low-pass filter turns into a high-pass filter. Therefore a high-pass filter is implemented by shorting the open-circuited stubs of a low-pass filter, for a high-pass filter of the same order and type.

4.3 Implementation of the Band-Pass and Band-Stop Filters

The characteristic impedances of the resonators of the designed band-pass and band-stop filters are shown in Table 3.1. The filters are implemented using open-wire parallel lines. Open-wires parallel lines used have 2.4 mm diameter. Open-wire lines with centre-to-centre spacing of 2.4 mm, equal to the diameter of each lines, have the characteristic impedance of 83 Ohms. Therefore band-pass and band-stop filters cannot be implemented using open-wire parallel lines.

4.4 Translation of the Filter Impedance

4.4.1 The Balun

A balun is a device used to convert a balanced line to an unbalanced line, and vice-versa [10]. It is used to connect the balanced open-wire line filter to the unbalanced coaxial cable. Each end of the filter is connected to a balun. The coaxial cable connects the filter to the signal source as well as to the filter load. If the open-wire line and the coaxial are connected without a balun, the open-wire line currents run on the outside of the coaxial to balance it, consequently coaxial cable radiates.

Transformers are used as baluns. The transformers, JTX-2-10T, used are unbalanced to balanced centre tap bought from Minicircuits®. They have a frequency range of 50 - 1000 MHz and an insertion loss of 1 dB in that range. The typical phase unbalance for 1 dB bandwidth is 3 degrees, while the typical amplitude unbalance for 1 dB bandwidth is 0.4 dB. The primary side connects to the coaxial cable. The secondary connects to

the filter. The transformers are again used for impedance transformation. They transform impedance of the filter to 50 Ohms, which is the standard impedance for RF and Microwave components.

4.4.2 Coaxial Cable

Coaxial cable is an unbalanced transmission line. It is used to connect a filter to the network vector analyser. One end of the coaxial cable is connected to the primary side of the transformer. The central conductor is connected to the primary DOT [Appendix B]. The outer conductor of the coaxial cable connects to the primary. The signal from the network vector analyser travels in the inner conductor of the coaxial cable. On the secondary side, the two open-wire parallel lines connect to the secondary DOT and the secondary.

4.4.3 Connectors

The coaxial cable is terminated with a BNC connector, which is fitted with a BNC to SMA connector. SMA connectors have a frequency limit of 18 GHz and have a maximum insertion loss of 0.3 dB [18]. Figure 4.2 shows the transformers connected back-to-back, the coaxial cable leads to the network vector analyser. Figure 4.3 demonstrates the transformers connected to the filter to transform impedance from 100 ohms to 50 ohms.



Figure 4.2: Transformers connected back-to-back and coaxial cable.

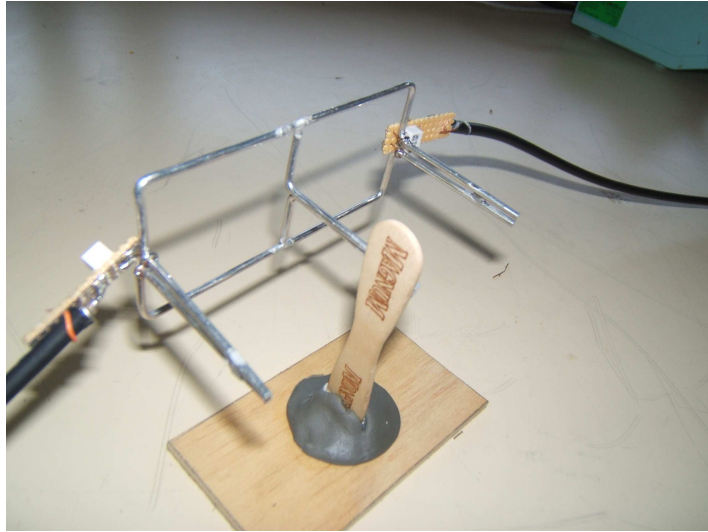

Figure 4.3: Transformers connected to the low-pass filter.

4.5 Summary

Open-wire lines are used to implement filters as they provide the two degrees of freedoms required for transmission line filter implementation. The length is fixed, while the characteristic impedance is changed by changing the centre-to-centre spacing of the two parallel open-wire lines.

The implemented filters have the right connectors to interface them to RF and Microwave equipment. The RG 58 C/U coaxial cable is used to feed the filter. Coaxial cable is ended with male BNC connectors to interface with RF and Microwave equipment. Coaxial cable is an unbalanced line, hence it needs a balun to link it to balanced open-wire lines. JTX-2-10T Minicircuits® transformers are used as baluns.

Band-pass and band-stop filters could not be implemented. The lowest characteristic impedance open-wire lines can attain is 83 Ohms. The highest impedance for band-pass resonators designed is 11 Ohms. As a result open-wire lines cannot implement filters using quarter-wave coupled quarter-wave resonators. The subsequent chapter details the testing of the filters.

Chapter 5

Testing

Most design work in the RF and Microwave field follows well established theory. In spite of that, the designs are tested to verify that they perform as stipulated by theory. The same logic applies to this project. The filters designed and implemented using transmission lines are tested to prove the design theory. Chapter five details tests conducted on the implemented filters.

5.1 E5071B Network Vector Analyser Calibration

The E5071B network vector analyser is used to test the filters, hence it is calibrated. The calibration is done with the frequency range set from 500 MHz to 1.1 GHz. The velocity factor is set to 1. The power level is put at 0 dB. The sweep time is automatic, while the sweep mode is set to standard stepped. Test signal is continuous. There is one marker that is placed at the cut-off point. Figure 5.1 demonstrates the test set up.

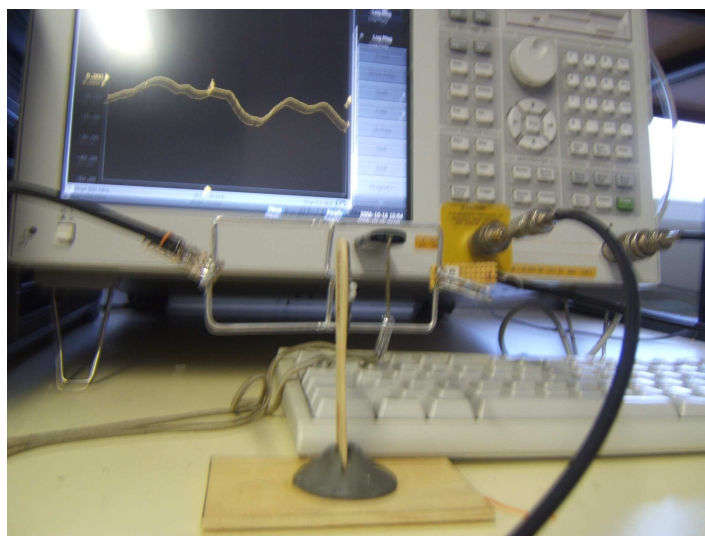

Figure 5.1: The test set up.

The first step is the open-circuit calibration on both ports. The calibration correction is put on. Port 1 is open-circuited, the logarithmic magnitude response is observed. The procedure is repeated on port 2. Then the network vector analyser is calibrated with the coaxial cable connected from port 1 to port 2. The coaxial cable has the two transformers connected back-to-back inserted midway. Figures 5.2 and 5.3 are the S_{11} and S_{21} magnitude responses of the coaxial cable transformers connection.

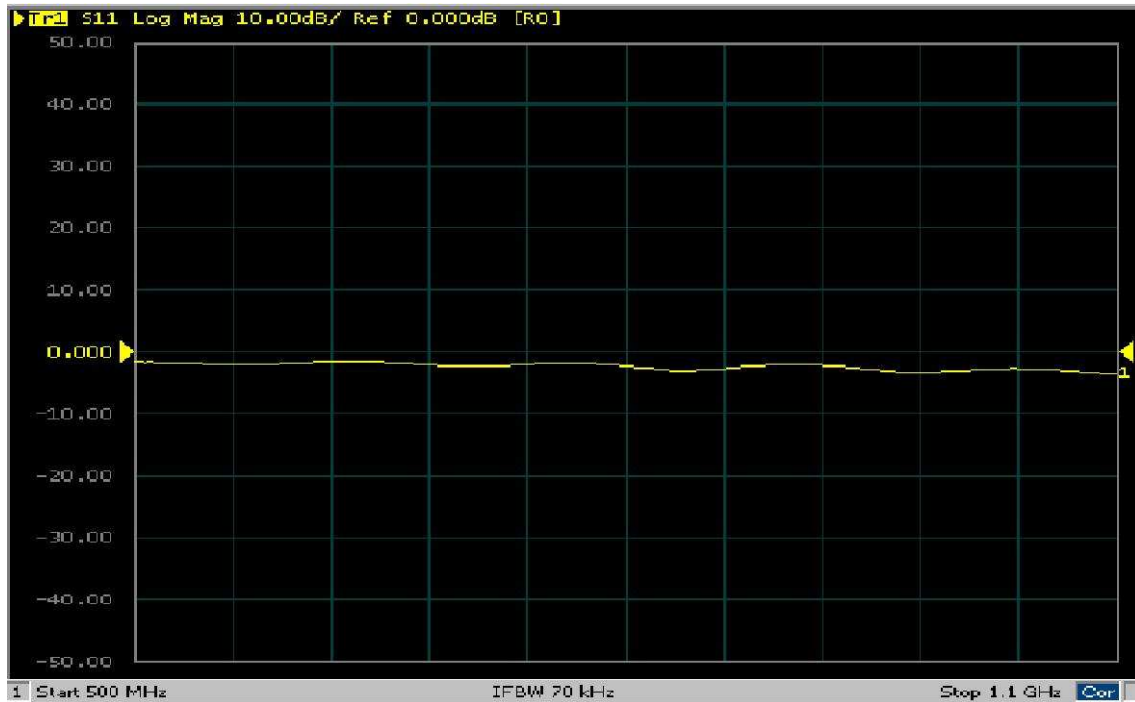

Figure 5.2: The plot of S_{11} .

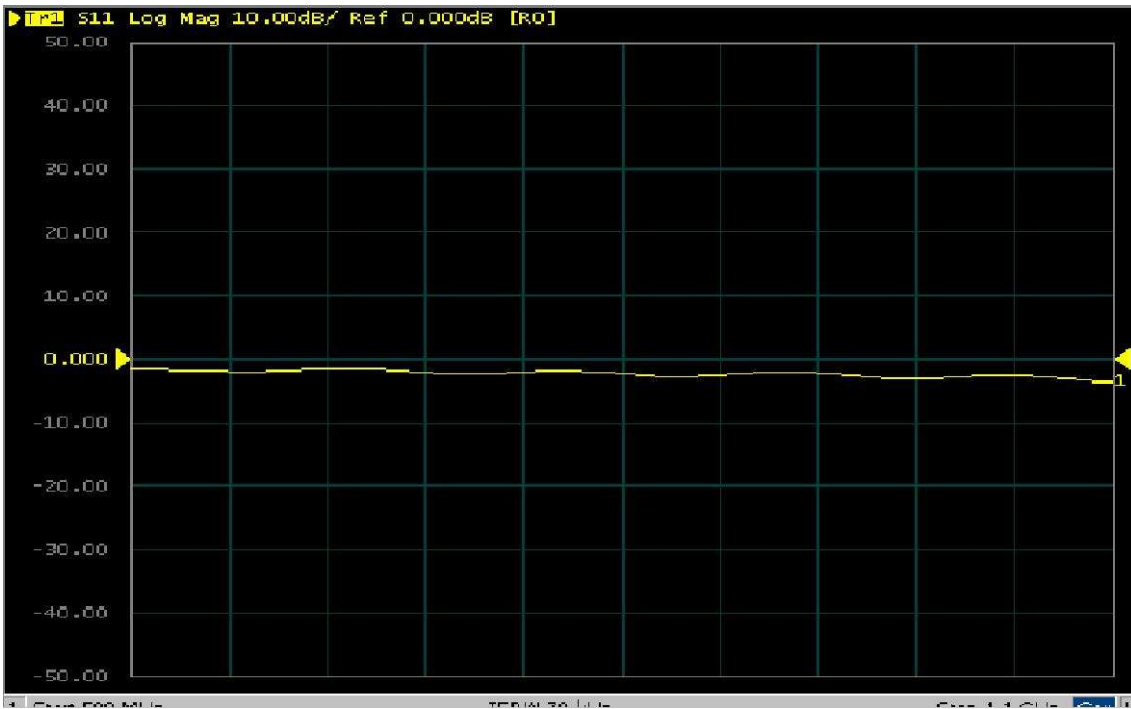

Figure 5.3: The plot of S_{21} .

5.2 Low-Pass Filter Test

Procedure

The low-pass filter is inserted between the two transformers. The network analyser is not turned off. The BNC connectors are disconnected. The transformers are joined to the two sides of the filter, and then the connectors are reconnected to the ports of the network analyser. The network analyser ports are fitted with the N to BNC adapters. The filter is placed as far away from conductors as possible as conductors in its vicinity distorts the open-wire lines electromagnetic pattern.

The logarithmic magnitude response of the low-pass filter is captured. Figure 5.4 is the logarithmic response of the low-pass filter. Figure 5.5 is the low-pass filter phase response in degrees. The group delay of the low-pass filter is shown in Figure 5.6.

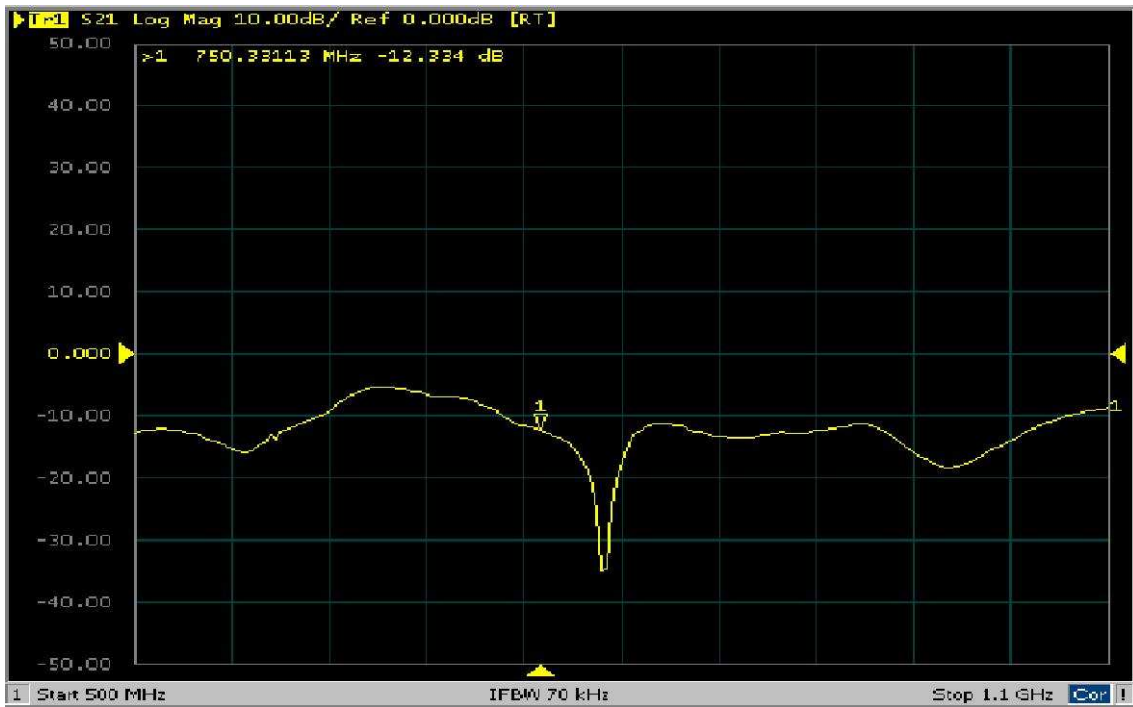

Figure 5.4: Magnitude response of the low-pass filter.



Figure 5.5: Phase response of the low-pass filter.

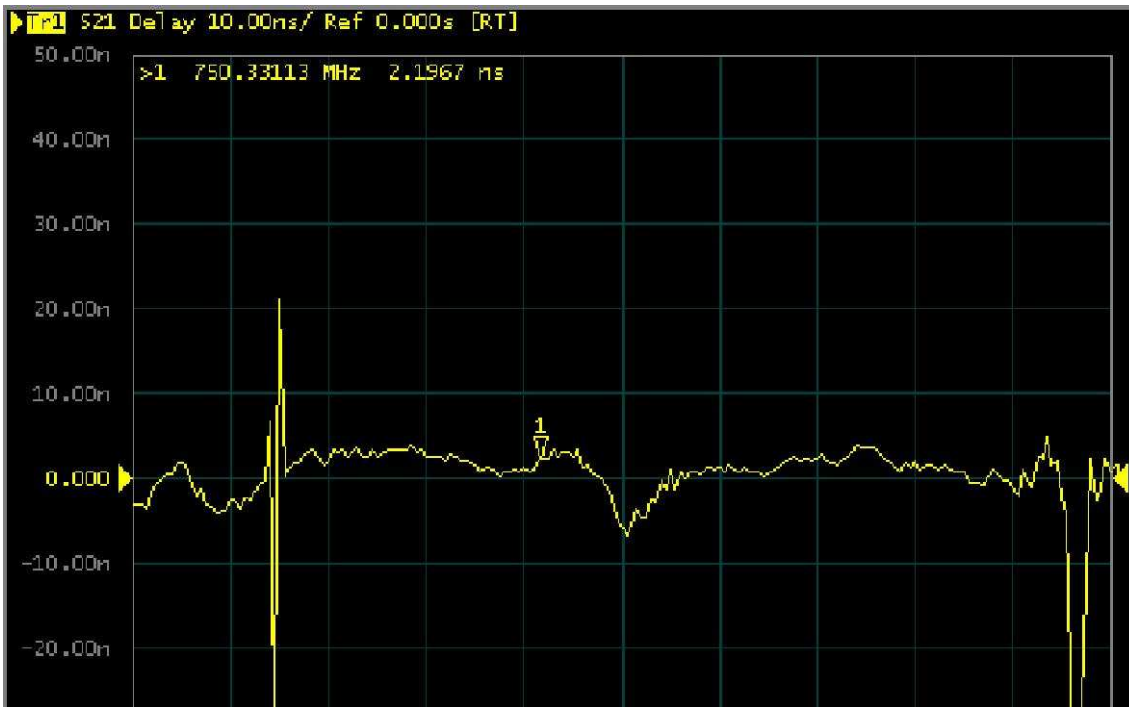

Figure 5.6: Group delay of the low-pass filter.

5.3 The High-Pass Filter Test

Procedure

The coaxial cable is ended with the BNC connector that connect to the network analyser. The network analyser is calibrated with the transformers connected back-to-back midway. The high-pass filter is placed in between the two transformers. The connectors are clipped back to the network analyser after the insertion of the high-pass filter. Any conductors close to the filter affect its electromagnetic waves.

The magnitude response of the high-pass filter is observed. The phase response and the group delay of the filter are also observed and compared to those of the low-pass filter. Figure 5.7 is the logarithmic magnitude response of the high-pass filter, Figure 5.8 is the phase response, while Figure 5.9 is the group delay of the filter.

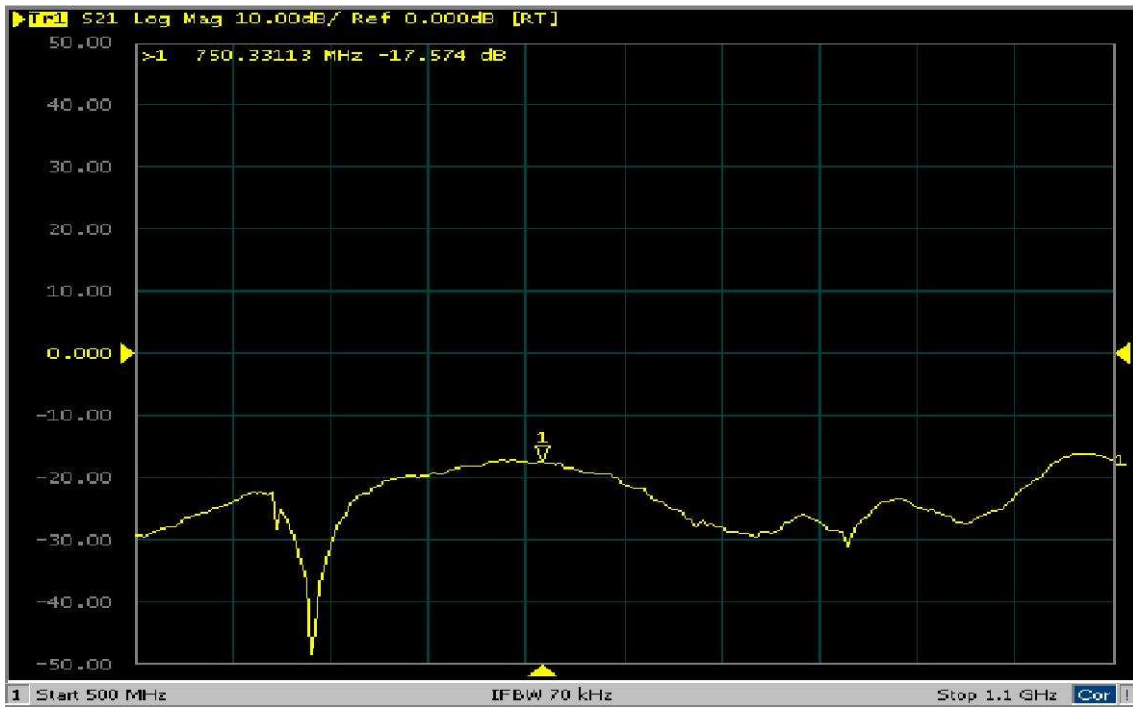

Figure 5.7: Magnitude response for a high-pass filter.

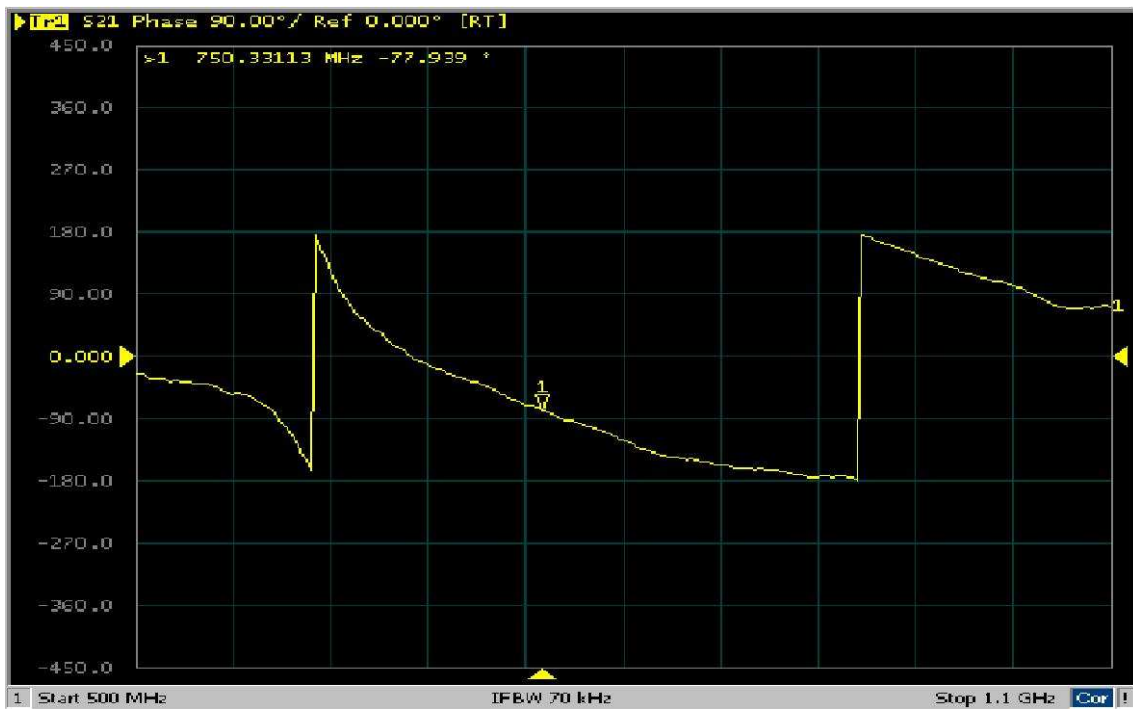

Figure 5.8: Phase response of the high-pass filter.

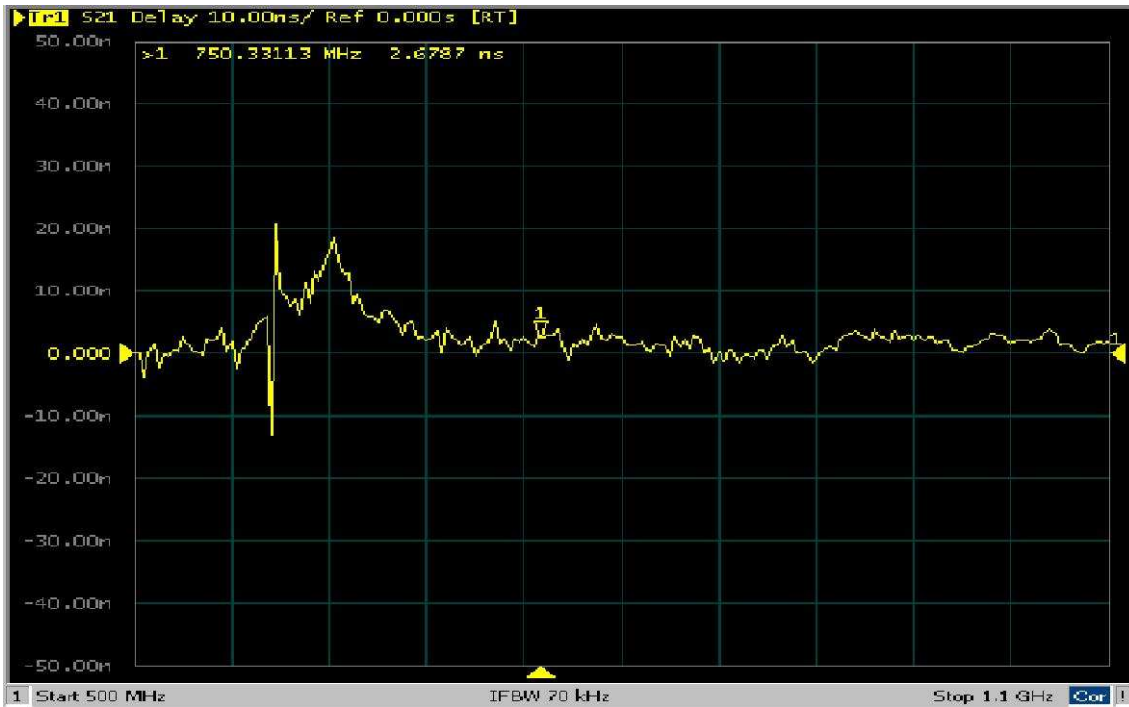

Figure 5.9: Group delay of a high-pass filter.

5.4 Discussion of Results

Phase Response

The implemented filters phase response is periodic, while phase response of the simulated filters is not. The implemented filters phase response varies from the simulated filters phase response. For high-pass filter, the phase response of the implemented filter represents a positive shift in frequency of the simulated filter phase response. The cut-off point of the implemented high-pass filter is at -77.9 degrees, while that of the simulated filter is at -180 degrees.

The phase response of the implemented low-pass filter is greatly distorted. But due to periodicity, the phase response of the low-pass filter can be derived from that of the high-pass filter. On a phase response graph, high-pass filter cut-off occurs at an absolute minimum, whilst low-pass filter cut-off occurs at an absolute maximum. Therefore the high-pass filter phase response can represent low-pass filter phase response. The implemented low-pass filter cut-off point leads the simulated filter cut-off point.

Group Delay

Equal-ripple filters have the worst group delay compared to maximally flat and linear phase filters. The group delay of the implemented filters ripples at the cut-off point by

about 2.1967 ns; the ripple repeats at higher and lower cut-offs due to periodicity and averages 20 ns. Ripples in group delay are responsible for signal distortion as certain frequencies in a signal are transmitted faster than others.

Magnitude Response

Low-pass and high-pass filters' magnitude response is compared to the simulated filter response of the lumped elements designs. Distributed components are periodic, so the implemented filters response is periodic while simulated filter response is not. The periodicity of the filters is $4\omega c$. Therefore the magnitude response repeats as seen in Figures 5.4 and 5.7. Furthermore the response is symmetric. For low-pass filters, the pass-band extends from the set cut-off to the lower cut-off. The shape recurs at higher frequencies. As the frequency increases the shape gets distorted because open-wires radiation increases with frequency of operation. Errors in lengths or spacing of open-wire lines also rise with frequency.

Simulated low-pass and high-pass filters have cut-off at -9 dB. Implemented low-pass filter has cut-off at -12 dB, while high-pass filter has cut-off at -17 dB. The high-pass filter is implemented by shorting the open-circuited stubs of the low-pass filter; that is the translation of the low-pass filter. The low-pass filter is shifted such that the lower cut-off of its pass-band becomes the cut-off of the high-pass filter. Pass-band power level of the low-pass filter has a maximum of -6 dB; high-pass filter power level reaches a maximum of -12 dB. The high-pass filter has lower power level than the low-pass filter because it results from the translation of the low-pass filter.

The simulated low-pass filter has the 3 dB ripple more pronounced than the simulated high-pass filter. For implemented filters the 3 dB equal-ripple band is deformed. The implemented low-pass filter rate of attenuation is initially slow in the stop-band. On the other hand the implemented high-pass filter cut-off is observed to be below 750 MHz. The reason for the deviations is the filters' physical dimensions. It is difficult to precisely separate wires by 1.1 mm - spacing for outer stub open-wire lines - for instance. As the filter has to be elevated to keep it at a distance from ground, it is a challenge to keep the alignment of the wires.

The biggest source of error is the connection of a filter to the secondary transformer side. 0.5 mm wire is used to connect a filter to a transformer on both sides. Secondary DOT and the secondary connect to the two lines of a filter. Since implemented filter have 100 Ohm characteristic impedance, the 0.5 mm wire should be separated by 0.575 mm. The required separation is not realised, the separation was over 2mm. With the 2 mm centre-to-centre separation, a filter is connected by 276 Ohm lines (not 100 Ohm as intended) to the transformer. Soldering the wires to a filter further introduces error because the solder decreases the separation of the lines.

The Q factor of the resonant circuit is important because it affects the sharpness of the response curve [19]. All practical inductors exhibit losses due to the resistance of the wire [19].

$$Q = \omega L/R$$

The skin effect increases the apparent resistance of the wire [20], thus it lowers the Q factor. Skin effect is the tendency of current to flow in the outer layer of the conductor; it increases greatly over 1MHz [19]. Over 1 MHz, the resistance of the wire increase with a decreasing diameter of the wire [20].

$$R = (8.32)10^{-5} \frac{\sqrt{f}}{d}$$

For a 2.4 mm diameter wire the resistance is 0.95 Ohm. The argument explains the blunt cut-offs observed for the implemented filters. The high resistance results in low Q factor. To get the low impedance stubs the open-wire lines are bent inwards to reduce centre-to-centre spacing. The bent wire is effectively an inductor, the increase in inductance results in an increase in resistance as inductors exhibit losses. The increase in resistance due to bent wire further decreases the Q factor.

Characteristic impedance of free space relates the electric and magnetic field intensities in an electromagnetic field propagating through a vacuum [21]. It is approximately 377 Ohms, the impedance of implemented filters ranges from 130 to 435 Ohms. Therefore the filter wires radiate energy as their impedance is around that of air, the radiated power contributes to the total losses of the signal passing through the filter. The other contribution to losses draws from the insertion loss of the transformers. The insertion loss of the transformer is 1.2 dB at the 750 MHz cut-off. Figure 5.3 illustrates insertion loss of the transformers - cable arrangement.

Chapter 6

Conclusions and Recommendations

6.1 Conclusions

Based on the preceding information the following conclusions have been drawn.

- 2.4 mm diameter open -wire parallel lines are used to implement RF and Microwave filters. It is easy to change the characteristic impedance of open-wire lines.
- Insertion loss method is used to design low-pass, high-pass, band-pass and band-stop filters. Band-pass and band-stop filters could not be implemented with open-wire lines.
- The periodicity of the open-wire line filters is not regular, accurate implementation improves the filter performance.
- A practical for the RF and Microwave engineering students has not been prepared.

6.2 Recommendations

On the basis of the conclusion made, the following recommendations are made.

- Work must be done straight away to prepare practical work for students taking RF and Microwave Systems course. For the practical students must be given open-wire lines, spacers, connectors and coaxial cable. They must cut the transmission lines themselves, use spacers and connectors to build filters of different types and orders. Students can then compare the behaviour of various filters.
- Low impedance microstrip should be investigated as an alternative means of implementing band-pass and band-stop filters.

- Suspended Substrate filters have air for a dielectric. Air has a high dielectric constant; therefore such filters could have a wide impedance range and should be explored.
- One way to implement band pass and band-stop filters is by coupled lines, it is recommended combline and interdigital filter design theory be reviewed for implementing filters.
- Filters are not constraint to tests on the network vector analyser. They are used together with other RF and Microwaves components, which normally have differing impedances of operation. Therefore filter design by the bisection method ought to be investigated to have filter of different input - output impedances.

Bibliography

- [1] George L. Matthaei, Leo Young, E. M. T. Jones. *Microwaves Filters, Impedance-Matching Networks, and Coupling Structures*. Reprint of the edition by McGraw-Hill. Dedham: Artech House, 1980.
- [2] David M. Pozar. *Microwave and RF Design of Wireless Systems*. First Edition. New York: John Wiley & Sons, 2001.
- [3] Percy Chinoy. Design Considerations for Thin-Film Embedded Resistors and Capacitors Technologies. Emerald Group, Volume 31, Number 1, page 21-27, 2005 [Online] Available: <http://www.emeraldinsight.com/Insight/ViewContentServlet?Filename=Published/EmeraldFullTextArticle/Articles/2170310103.html>
- [4] R. Ludwig. RF and Microwave Engineering, University of San Diego. [Online] Available: www.sandiego.edu/~ekim/e194rfs01/filtererek.pdf
- [5] J. A. G. Malherbe. *Microwave Transmission Line Filters*. First Edition. Dedham: Artech House, 1979
- [6] S. Darlington. Synthesis of Reactance 4-poles Which Produce Prescribed Insertion Loss Characteristics. *Journal of Mathematics and Physics*, Volume 18, September, 1939
- [7] Unknown Author. Institute for Telecommunication Sciences. 23 August 1996 [Online] Available: http://www.its.blrdoc.gov/fs-1037/dir-019/_2746.htm
- [8] Unknown Author. *Microwaves101.com, Coaxial Cable*. 1 October 2006 [Online] Available: <http://www.microwaves101.com/encyclopedia/coax.cfm#coax>
- [9] Unknown Author. *SearchNetworking.com, Coaxial cable*. 15 June 2005 [Online] Available: http://searchnetworking.techtarget.com/sDefinition/0,,sid7_gci211806,00.html
- [10] Fred Johnson. *The New Zealand Amateur Radio Study Guide, Transmission Lines*. [Online] Available: <http://www.nzart.org.nz/>

nzart/examinat/amateur%20radio%20study%20guide/Course%
20Files/Transmission%20Lines/

- [11] L. B. Cebik. Antennas Service and Education for Amateur Radio Operators, Transmission lines. 09 January 2006 [Online] Available: <http://www.cebik.com/trans/par.html>
- [12] David Jefferies. What is a microstrip transmission line. 2 February 2006 [Online] Available: <http://www.ee.surrey.ac.uk/Personal/D.Jefferies/mstrip.html>
- [13] Unknown Author. CV Chemandy Electronics, Microstrip Transmission Line Characteristic Impedance. 30 September 2006 [Online] Available: http://chemandy.com/calculators/microstrip_transmission_line_calculator.htm
- [14] Unknown Author. Amphenol RF, BNC Connector Series. Copyright 2003 [Online] Available: <http://www.amphenolrf.com/products/bnc.asp>
- [15] Barry Downing. Transmission Lines. EEE355F Module B Set of Notes, University of Cape Town.
- [16] Unknown Author. Agilent AN 1287-1, Understanding the Fundamental Principles of Vector Network Analysis. Copyrights 1997 [Online] Available: www.home.agilent.com/agilent/redirector.jsp?
- [17] Unknown Author. Peterson Cutter Owner's Group, Electrical Conductivity of Materials. 24 January 2006 [Online] Available: <http://www.kp44.org/ftp/ElectricalConductivityOfMaterials.php>
- [18] Unknown Author. Coax-Connectors, Connectors, Cable Assemblies and Network Products. [Online] Available: [:http://www.coax-connectors.com/coax-connectors.htm](http://www.coax-connectors.com/coax-connectors.htm)
- [19] R. Clarke. Power Losses in Wound Components, Electrical Engineering Department, Surrey. 09 January 2006 [Online] Available: http://www.ee.surrey.ac.uk/Workshop/advice/coils/power_loss.html#top
- [20] A.J. Wilkinson. Skin Effect in Conducting Wires, EEE355F Module A Set of Notes, University of Cape Town.
- [21] Unknown Author. Characteristic Impedance of Free Space, Whatis.com. [Online] Available: http://whatis.techtarget.com/definition/0,,sid9_gci845268,00.html

Appendix A

The Kuroda Identities

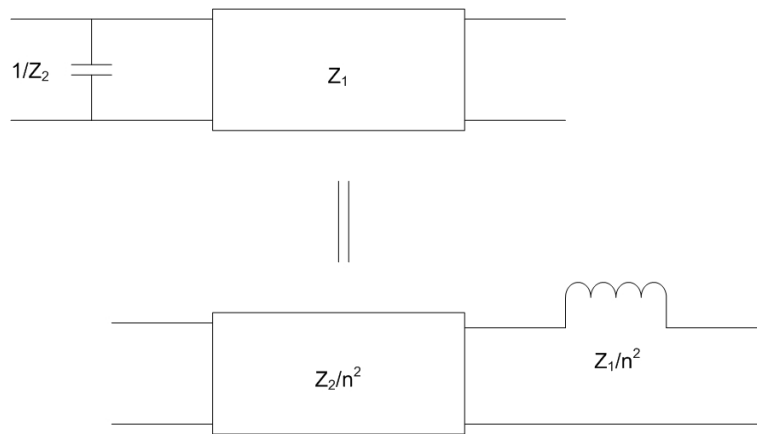

Figure 1: a

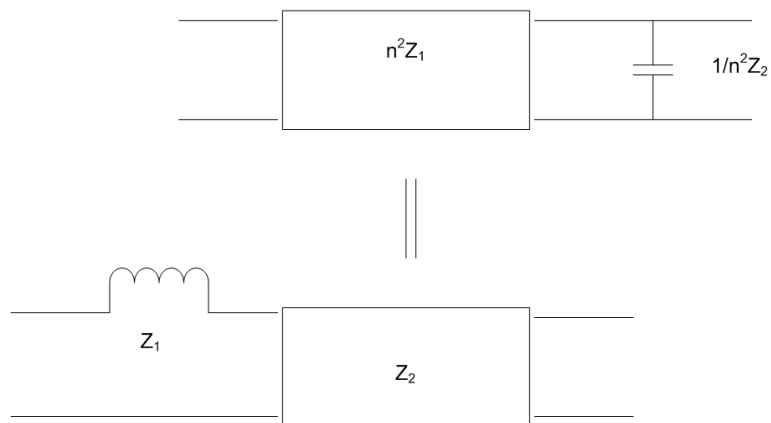

Figure 2: b

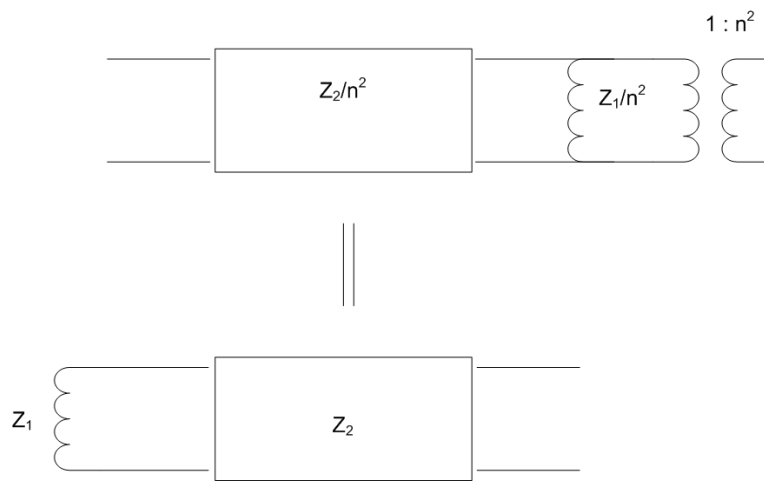

Figure 3: c

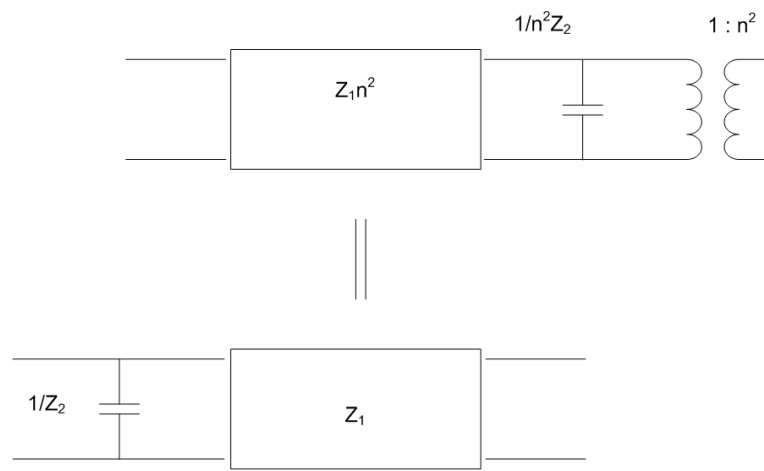

Figure 4: d

Appendix B

Transformer Data Sheet

Surface Mount RF Transformer

75Ω 50 to 1000 MHz

JTX-2-10T+ JTX-2-10T



CASE STYLE: BH292
PRICE: \$6.95 ea. QTY (10-49)

+ RoHS compliant in accordance
with EU Directive (2002/95/EC)

The + suffix identifies RoHS Compliance. See our web site
for RoHS Compliance methodology and qualifications.

Maximum Ratings

Operating Temperature	-20°C to 85°C
Storage Temperature	-55°C to 100°C
RF Power	0.25W
DC Current	30mA

Pin Connections

PRIMARY DOT	3
PRIMARY	1
SECONDARY DOT	6
SECONDARY	4
SECONDARY CT	5
NOT USED	2

Outline Drawing

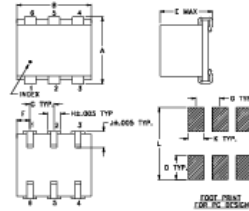

Outline Dimensions (inches)

A	B	C	D	E	F	G
.280	.310	—	.100	.225	.055	.100
7.11	7.87	—	2.54	5.72	1.40	2.54

H	J	K	L	wt
.047	.085	.065	.300	grams
1.19	1.85	1.65	7.62	0.45

Config. A



Features

- excellent return loss, 26 dB typ. in 1 dB bandwidth
- excellent amplitude unbalance, 0.4 dB typ.
- and phase unbalance, 3 deg. typ. in 1 dB bandwidth
- excellent insertion loss flatness, ±0.25 dB

Applications

- impedance matching
- balanced amplifiers

Transformer Electrical Specifications

Q	RATIO	FREQUENCY (MHz)	INSERTION LOSS*			PHASE UNBALANCE (Deg.) Typ.		AMPLITUDE UNBALANCE (dB) Typ.	
			3 dB MHz	2 dB MHz	1 dB MHz	1 dB bandwidth	2 dB bandwidth	1 dB bandwidth	2 dB bandwidth
2	—	50-1000	—	—	50-1000	3	—	0.4	—

*Insertion Loss is referenced to mid-band loss, 1.5 dB typ.

Typical Performance Data

FREQUENCY (MHz)	INSERTION LOSS (dB)	INPUT R. LOSS (dB)	AMPLITUDE UNBALANCE (dB)	PHASE UNBALANCE (Deg.)
50.00	1.65	19.25	0.03	0.18
70.00	1.53	22.13	0.04	0.38
100.00	1.48	25.62	0.10	0.68
300.00	1.35	30.86	0.02	2.40
400.00	1.42	33.04	0.10	2.27
800.00	1.28	34.12	0.23	2.01
700.00	1.20	33.89	0.27	0.68
850.00	1.30	32.48	0.36	0.87
900.00	1.16	30.98	0.34	1.40
1000.00	1.28	21.44	0.19	2.47

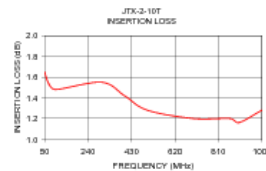

Mini-Circuits®

INTERNET <http://www.minicircuits.com>

P.O. Box 350186, Brooklyn, New York 11235-0038 (718) 954-4500 Fax (718) 332-4681

Distribution Centers NORTH AMERICA 800-654-7049 • 417-335-5935 • Fax 417-335-5945 • EUROPE 44-1252-832600 • Fax 44-1252-837010

Mini-Circuits ISO 9001 & ISO 14001 Certified



REV. D
4/02/00
170-917
EQ-4-425
OUTLINE
06010

